

# Right Connections

towbar wiring kits for the uk

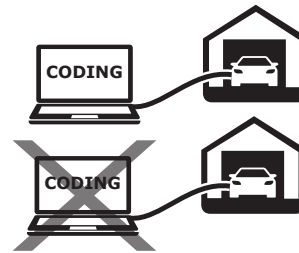

**Right Connections Duplex-Kit**

Tow bar wiring harness  
7pin/ISO1724 including  
two different operation-modes

**CUPRA**

**Tavascan (KR1) 03/2024 >>**

**Vehicles with and without trailer preparation!**

**Part No: VW-305-07M**

## Electric wiring kit for towbars / 7-pin / 12N / 12 Volt / ISO 1724 Fitting instructions

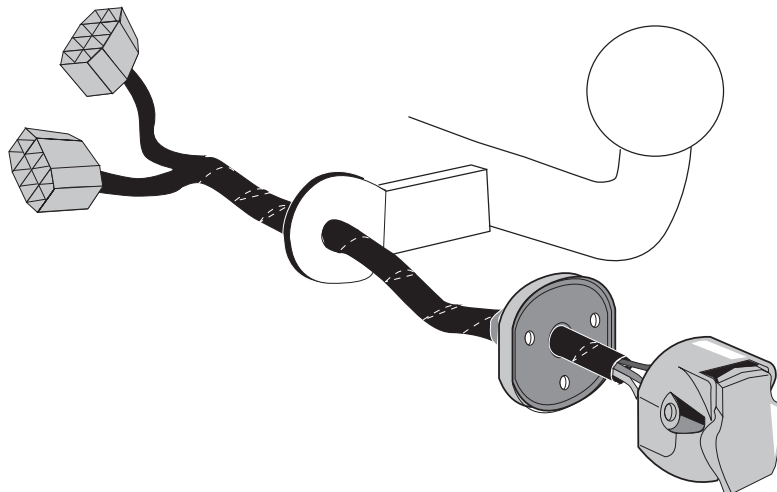

### IMPORTANT!

The installation of the towing electrics kit must be carried out by a qualified car technician. No claim can be made for compensation or legal liability in case the kit is improperly installed or modified, in case the vehicle is insufficiently coded, or in case technical changes (software-updates) are made after the towing electrics kit has been put into operation, for example during product recalls by the vehicle manufacturer or OTA maintaining (Over-The-Air software updates). Before installing the towing electrics kit, you must verify the compatibility of the vehicle and the towing electrics kit. Evaluate vehicle fault memory. Only start installation on a fault-free vehicle. Read the fitting instructions completely. In case of questions, please contact technical support: [Technical@rightconnect.co.uk](mailto:Technical@rightconnect.co.uk) and/or 01952 608750 OPT 2. The installation manual contains important information and must be kept with the vehicle service documents after the installation of the towing electrics kit. Vehicle manufacturer diagnostic systems do not have access to the internal fault memory of the trailer module. Error logs in diagnostic processes may be due to improper installation or insufficient coding of the vehicle. If necessary, disconnect the trailer module and repeat the diagnostic process. Limit the time for troubleshooting to a maximum of 0,5 hours and contact technical support in case of any problems. The trailer socket test must be carried out with a suitable test device, a trailer or a load carrier. LED test plugs without load resistors are not suitable for a proper function test. Trailer or load carriers must be equipped with a rear fog light. If a trailer socket adaptor has been used, this must be removed from the trailer socket after trailer operation. All information and illustrations shown are non-binding. Subject to technical changes.

1/27

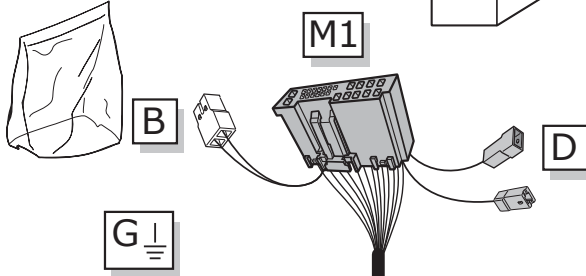

**\*Option**

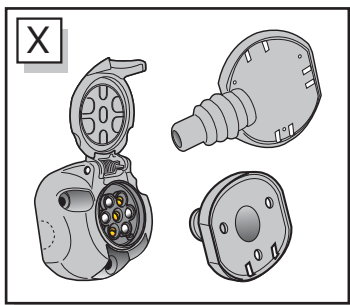
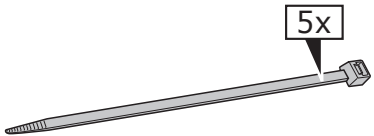

- 3x
- 3x
- 3x
- 1x
- 10x
- 2x
- 2x
- 3x
- 1x
- B

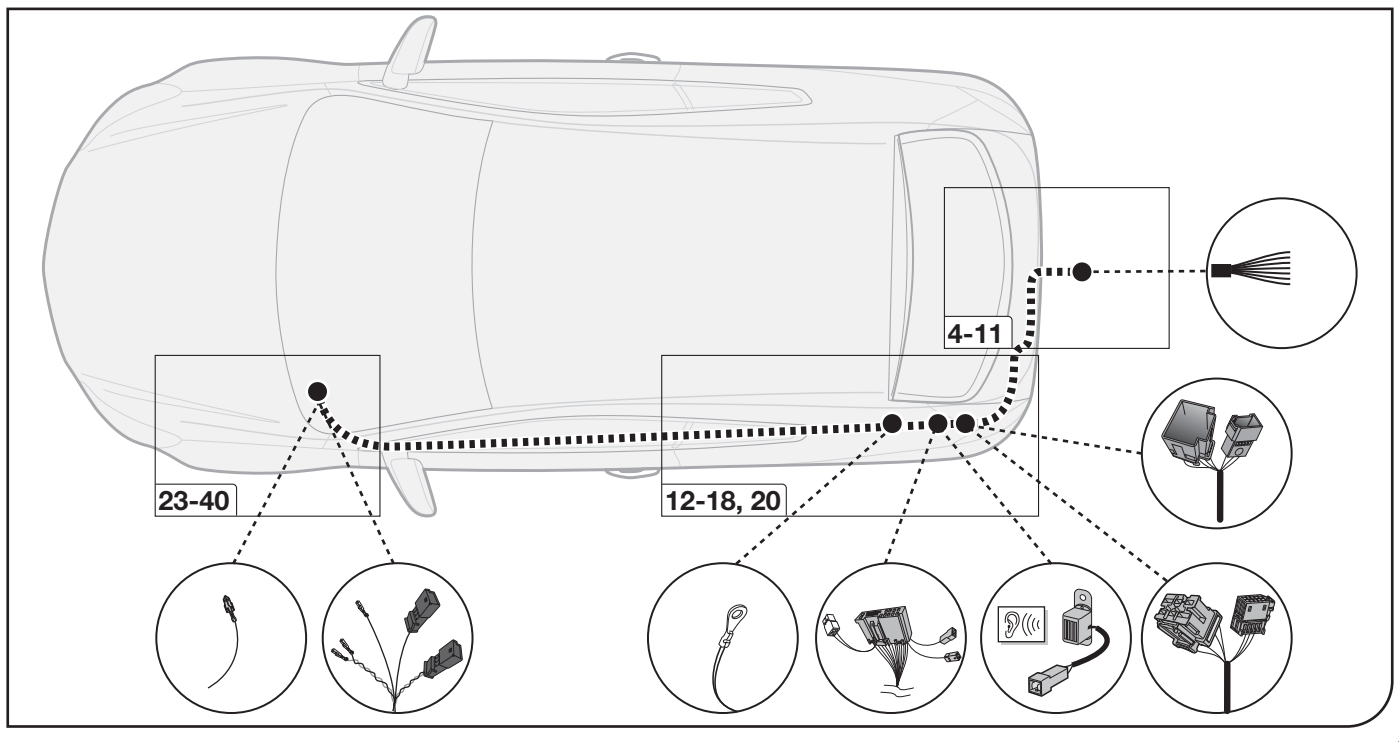

## Duplex-Mode 1 - With Coding (read/write)

### INFO

vehicles are currently not prepared for coding  
please use Duplex-Mode 2

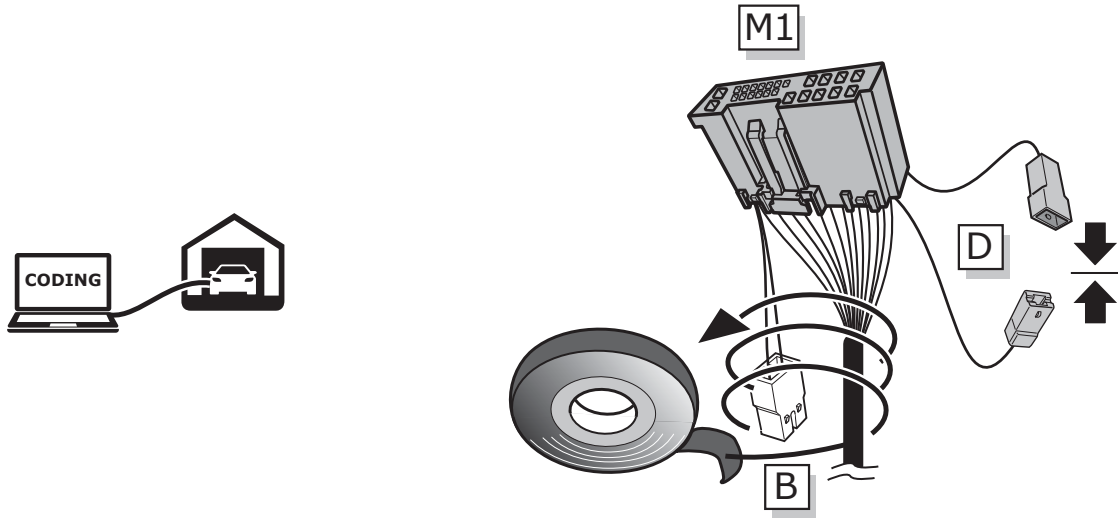

## Duplex-Mode 2 - Without Coding (read-only)

### INFO

Cupra Tavascan (KR1) 03/2024 >>

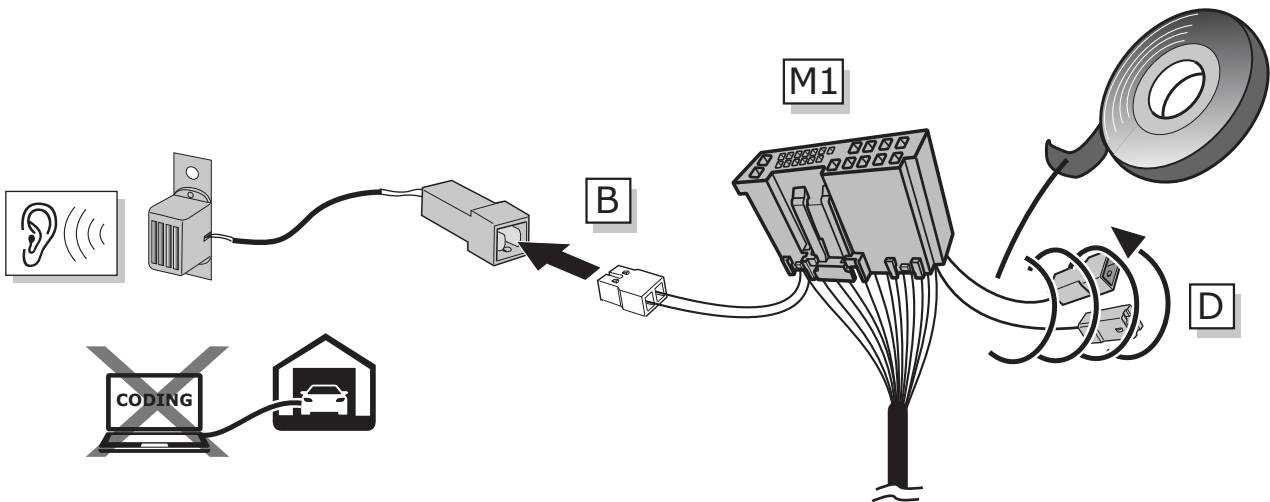

Vehicles with the equipment codes NI1, NI7, NI8, and NI9 currently cannot be coded for trailer operation. The so-called PR codes NI1, NI7, NI8, and NI9 represent an extended protection device from Volkswagen AG (SFD2), which will be implemented starting August 2023 and now affects all models. For vehicles with the aforementioned PR codes, the ECS Duplex installation kit must be installed in read-only mode as described above.

## Duplex-Mode 2 - Without Coding (read-only)



### Please note:

This wiring kit does not support any vehicle assistance systems in Duplex 2 mode (read-only). Assistance systems may need to be deactivated manually when towing a trailer or load carrier. The rear fog light of the vehicle is not deactivated when towing a trailer. After the towing electrics kit has been put into initial operation, manual deactivation of assistance systems may, in exceptional cases, be subsequently restricted by the vehicle manufacturer through software updates. Any warranty from ECS is expressly excluded in this case. Please contact the vehicle manufacturer.

## Duplex-Mode 2 - Without Coding (read-only)

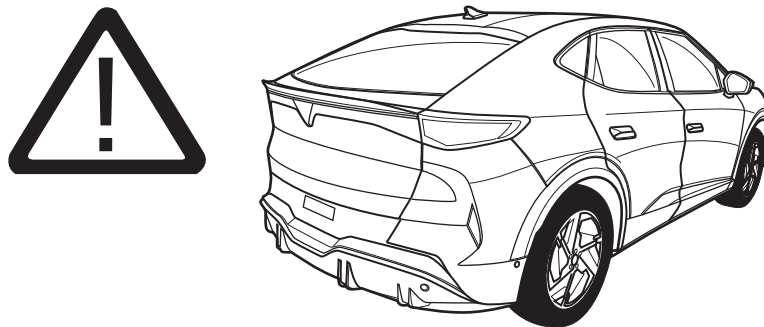

### Please note:

The electric tailgate will continue to operate even when a load carrier/trailer/caravan is connected and must be operated manually to avoid damage. Automatic or remote-controlled parking assistance systems must not be used when towing a trailer.

## SYMBOL EXPLANATION

58L	Left taillight (58-L)
58R	Right taillight (58-R)
54	Stop light (54) / high mounted, third stop light (54)
	Turn signal indicator left
	Turn signal indicator right
	Rear fog light(s)
	Reversing lights(s)
+30	Permanent power supply / 13pin socket, chamber 9
+15	Charging wire for trailer battery / 13pin socket, chamber 10
	Trailer / Trailer recognition
<b>+30</b>	Permanent current power supply
<b>+15</b>	Voltage after ignition

	Ground or Earth (31)
	Ground connection battery terminal lug
	Positive connection battery terminal lug
	Fuse / fuse capacity 20 Amp
	Loudspeaker / buzzer
	Park distance control
	Switch / source of function
	Connect together
	Disconnect
	PDC cut off
	Look carefully at selected area
	Present / Occupied / OK

	Not present / Not occupied / not OK
	Left
	Right
	Acoustic indication
	Attention / important advice
	Reusable
	Trash bin
	Use tape
<b>OPTION</b>	Option
<b>INFO</b>	Information
	Measure the voltage
NO NC COMMON	Normally open Normally close Common

## TOOLS

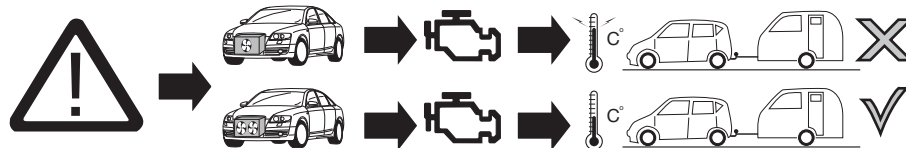
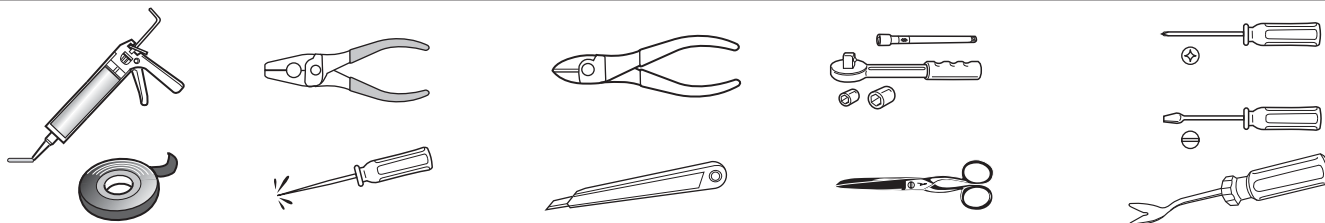

**ATTENTION!** The vehicle's cooling capacity may have to be increased when retrofitting a trailer coupling! You must observe the manufacturer's instructions!!

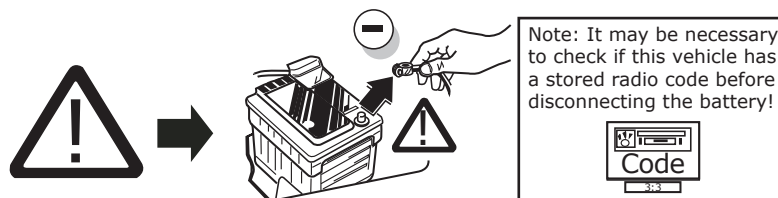

**ATTENTION!** In order to avoid mal-functions and damage to the vehicle's electrical system the earth terminal **must be disconnected** from the vehicle's battery **before starting work!**

**1** Both the trailer module and the vehicle's control unit for the electrical system can be damaged during work on the data bus connections if the battery is not disconnected!

Please pay attention to the manufacturer's instructions when disconnecting and reconnecting the vehicle's battery!

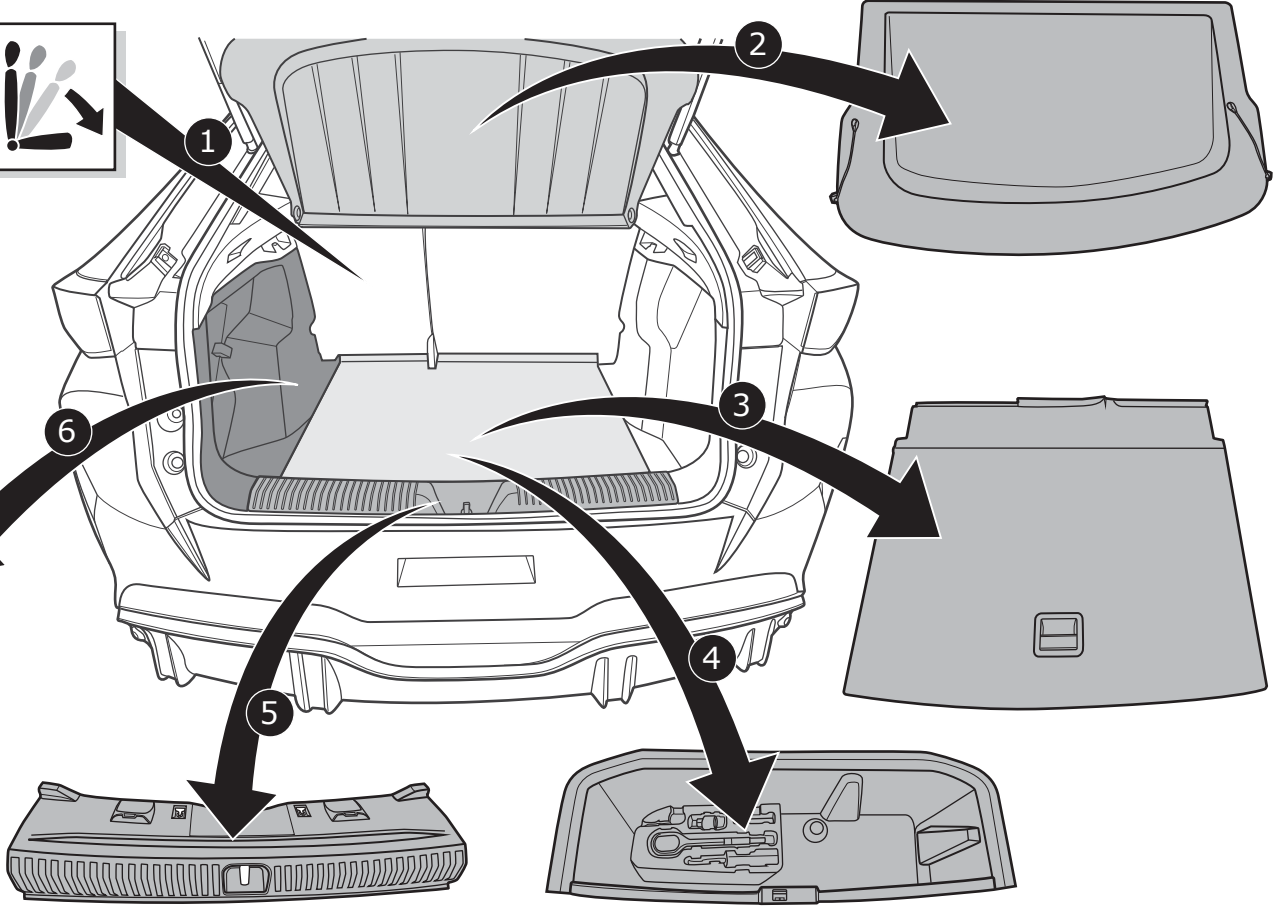
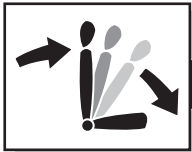

2

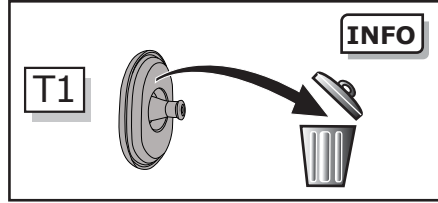
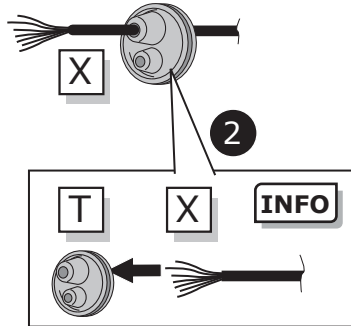
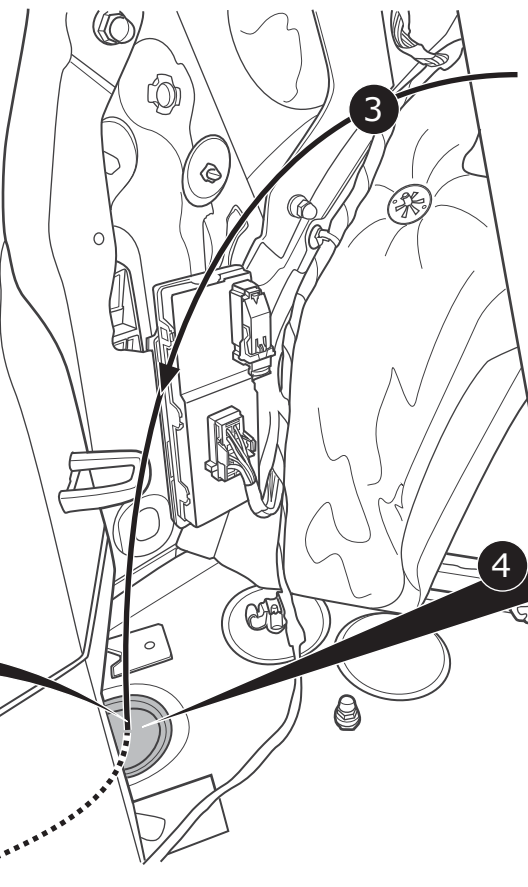
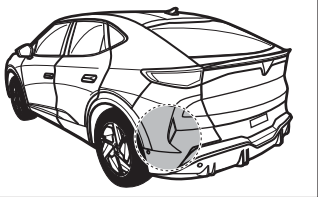

3

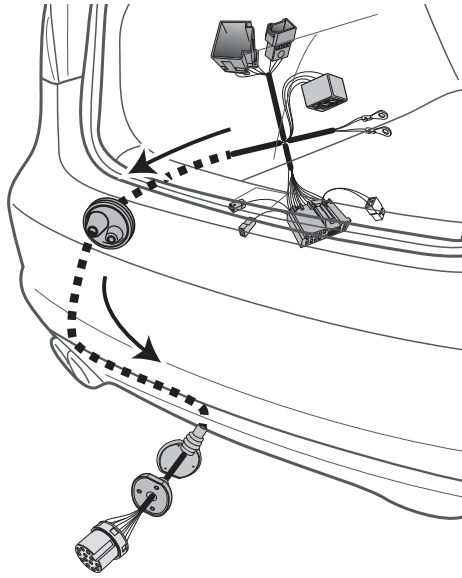

4

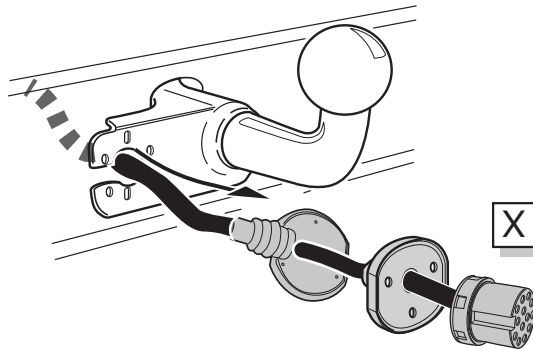

5

SOCKET CONNECTION



6

Option 1

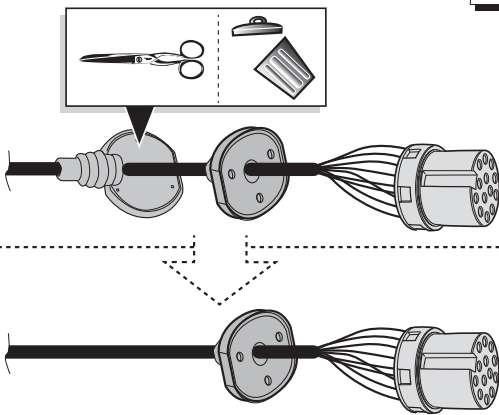

Option 2

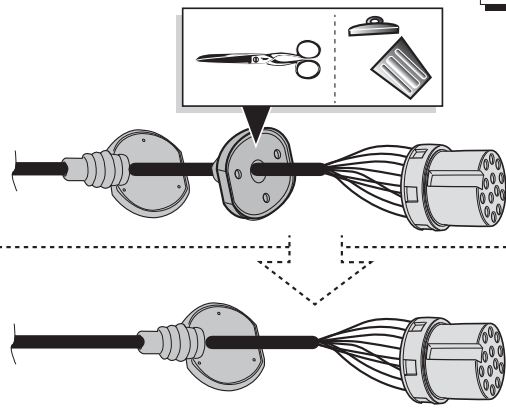

7

8

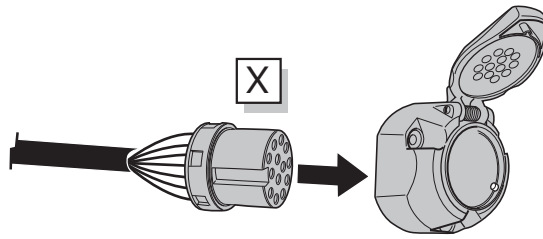

Option 1

9

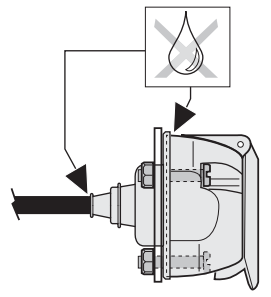
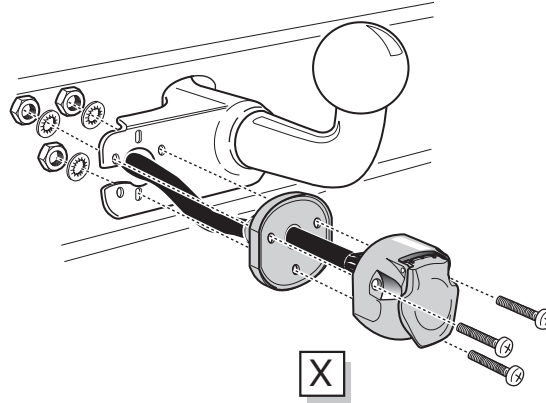

Option 2

10

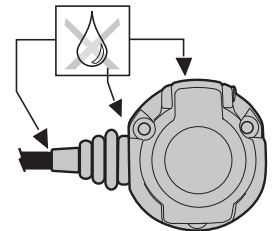
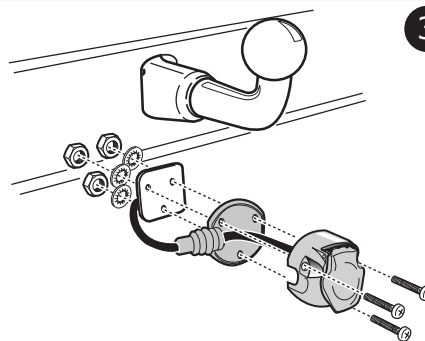
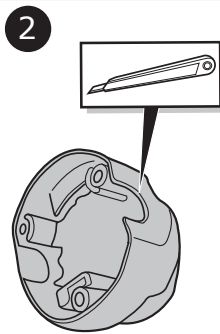
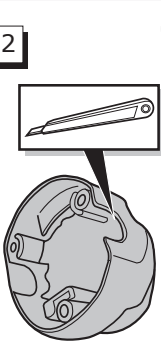

Option 2

11

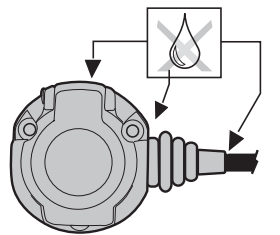
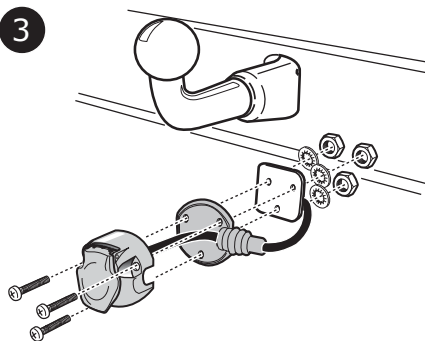
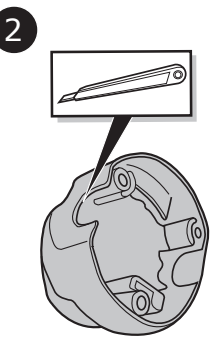
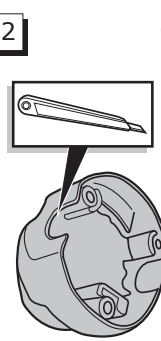

### Duplex-Mode 2 - Without Coding (read-only)

12

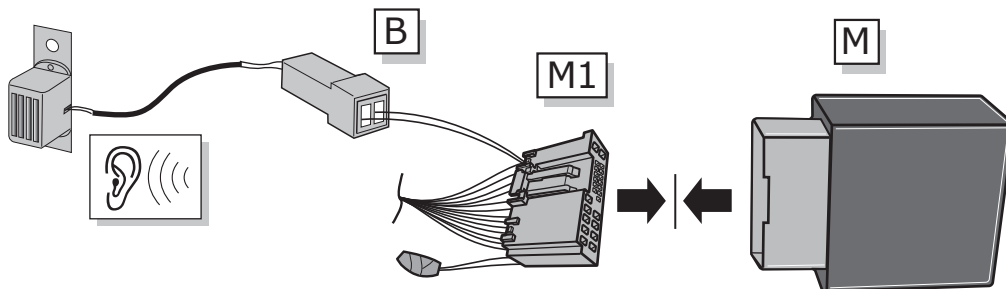

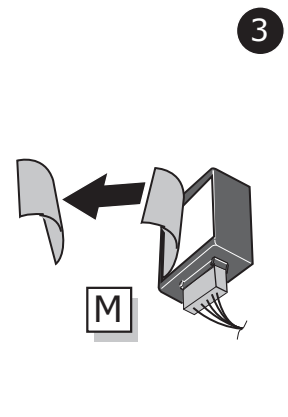
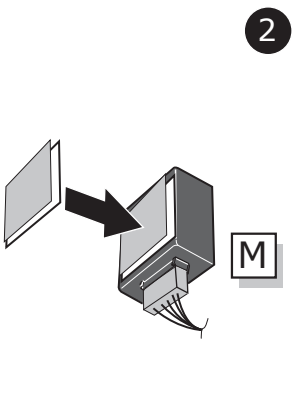
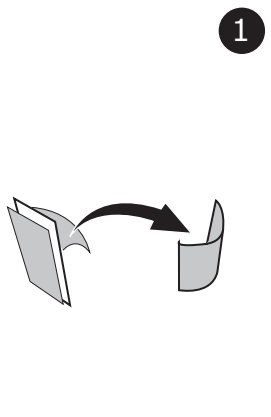
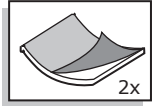

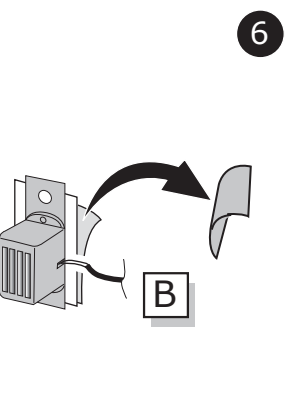
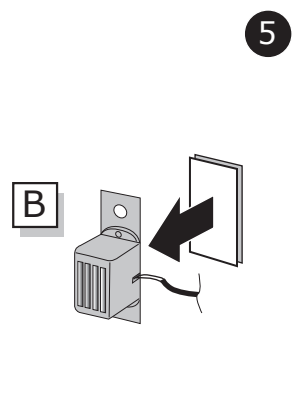

**Duplex-Mode 2 Without Coding**

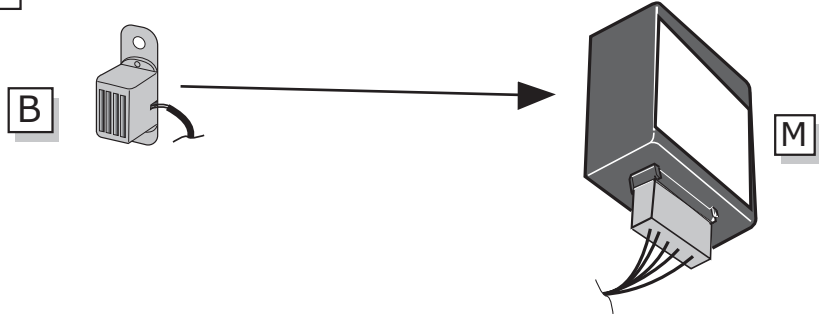

13

**Duplex-Mode 2 Without Coding**



14

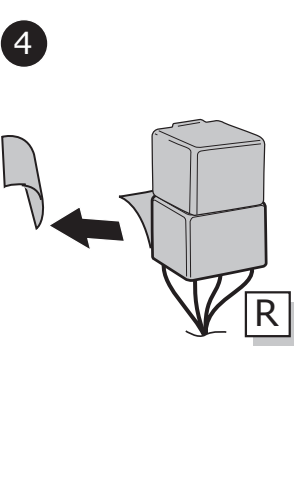
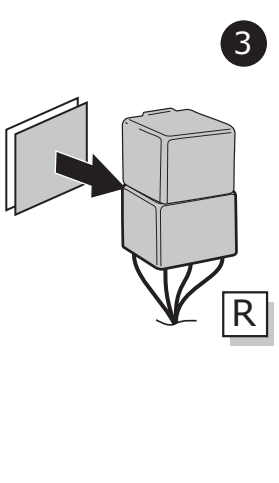
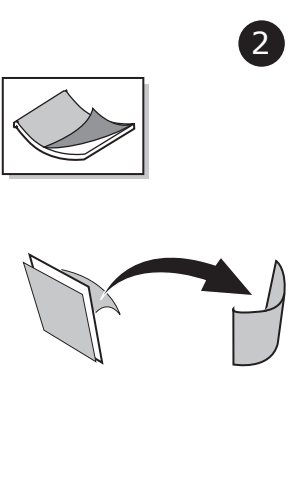
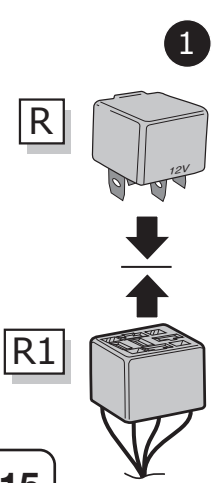

15

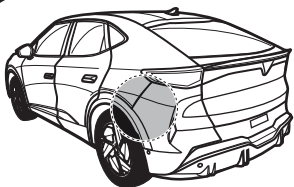

M

1

2

3

GND

10 mm

16

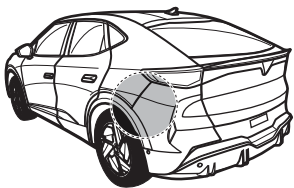

Black/Purple 6 pin

Black 10 pin

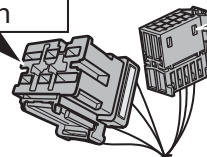

Vehicles **with** trailer preparation



18 → 19

41 → 53

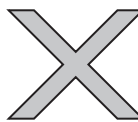
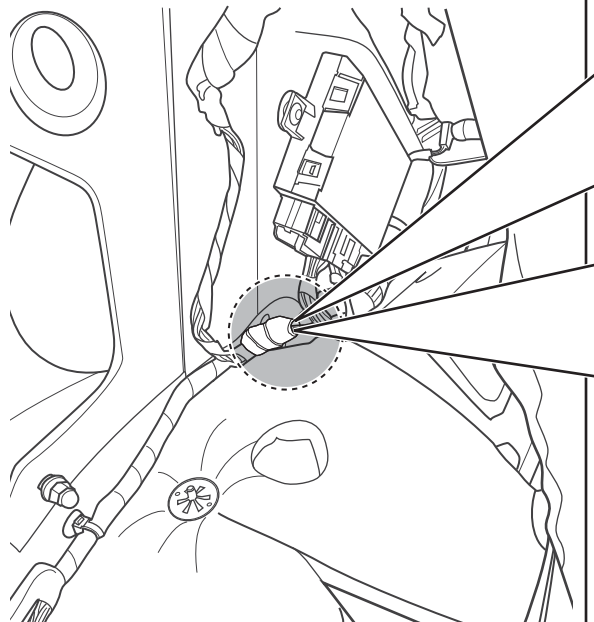

Black/Purple 6 pin

Black 10 pin

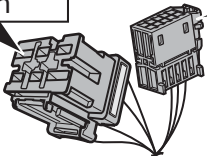

Vehicles **without** trailer preparation



20 → 53

17

Vehicles **with** trailer preparation

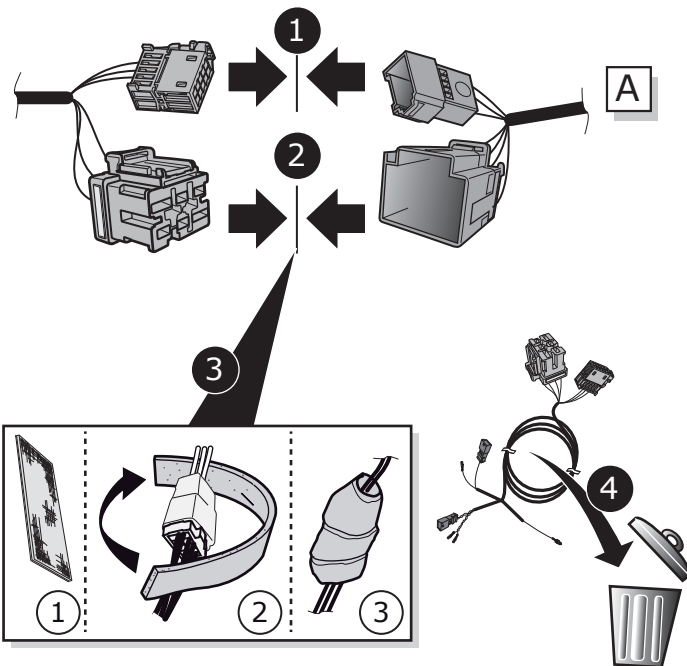
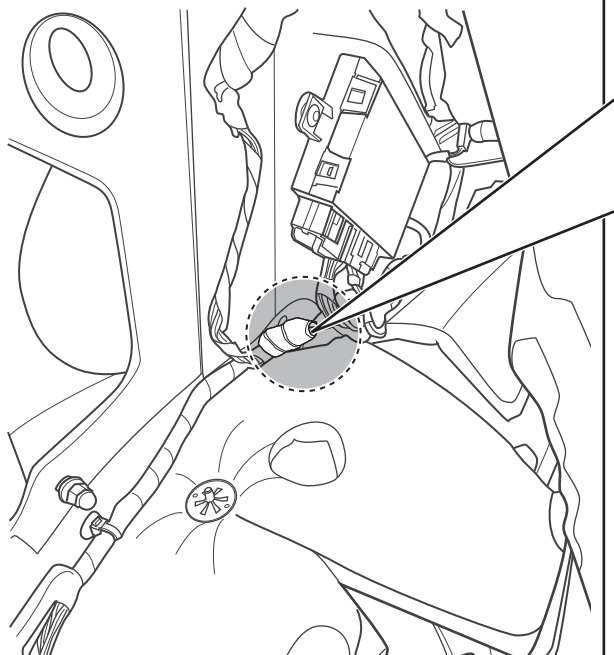
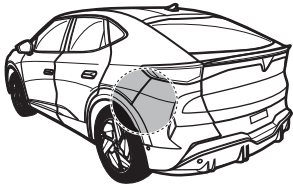

18

Vehicles **with** trailer preparation

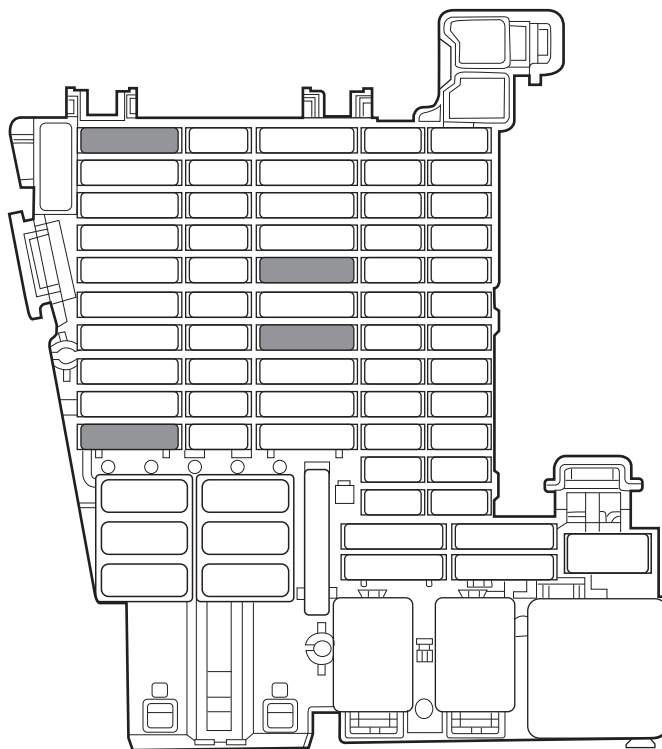
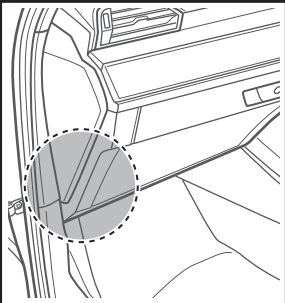

19

Vehicles **without** trailer preparation

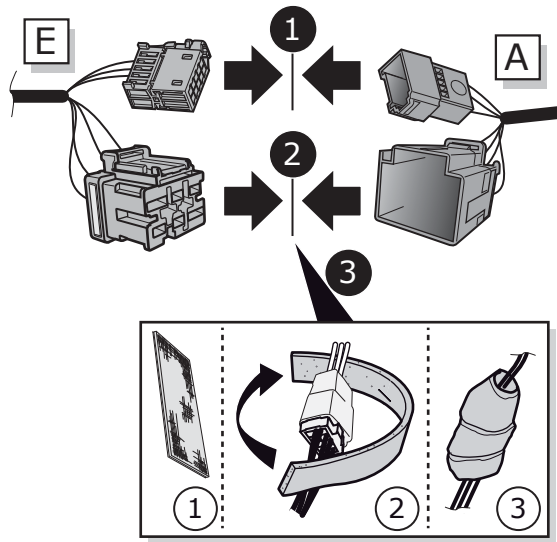
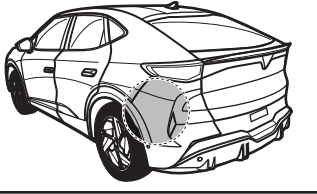

20

Vehicles **without** trailer preparation

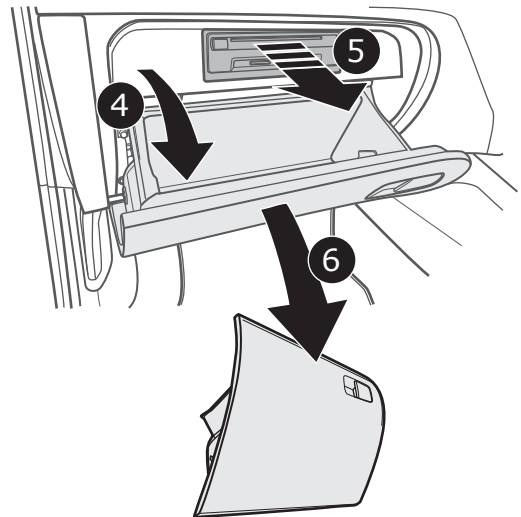
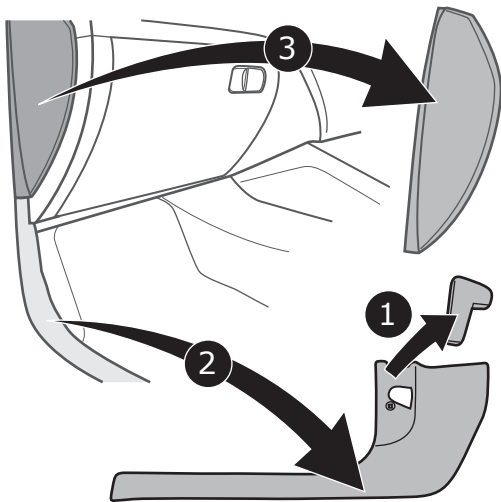

21

Vehicles **without** trailer preparation

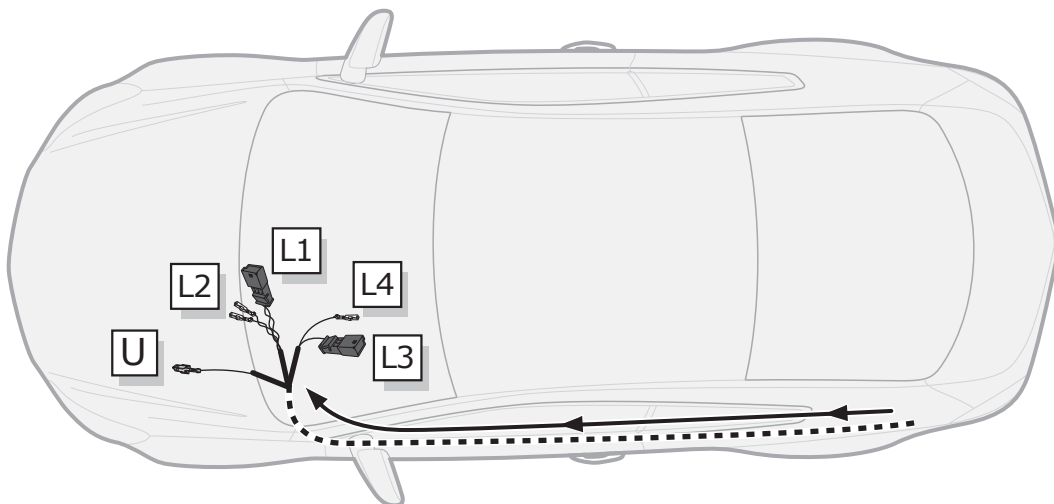

22

Vehicles **without** trailer preparation

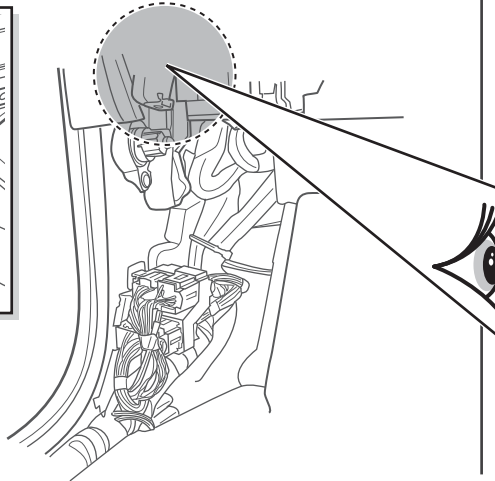
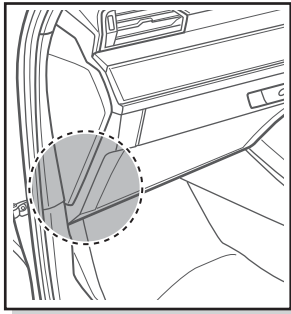

**Body Control Module**

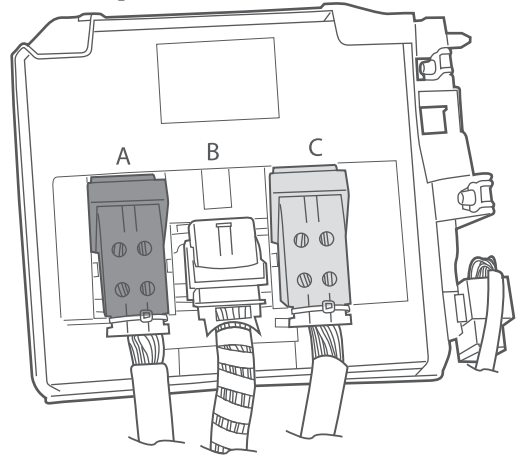

23

Vehicles **without** trailer preparation

CANbus  
**OPTION A**

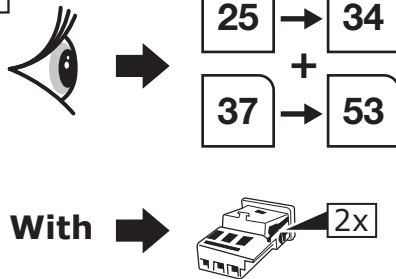

CANbus  
**OPTION B**

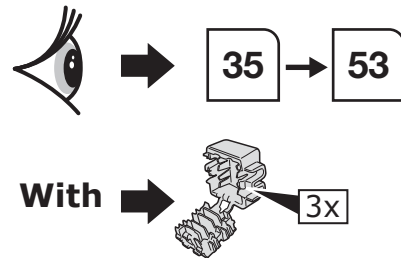

24

Vehicles **without** trailer preparation

CANbus  
**OPTION A**

**Body Control Module**

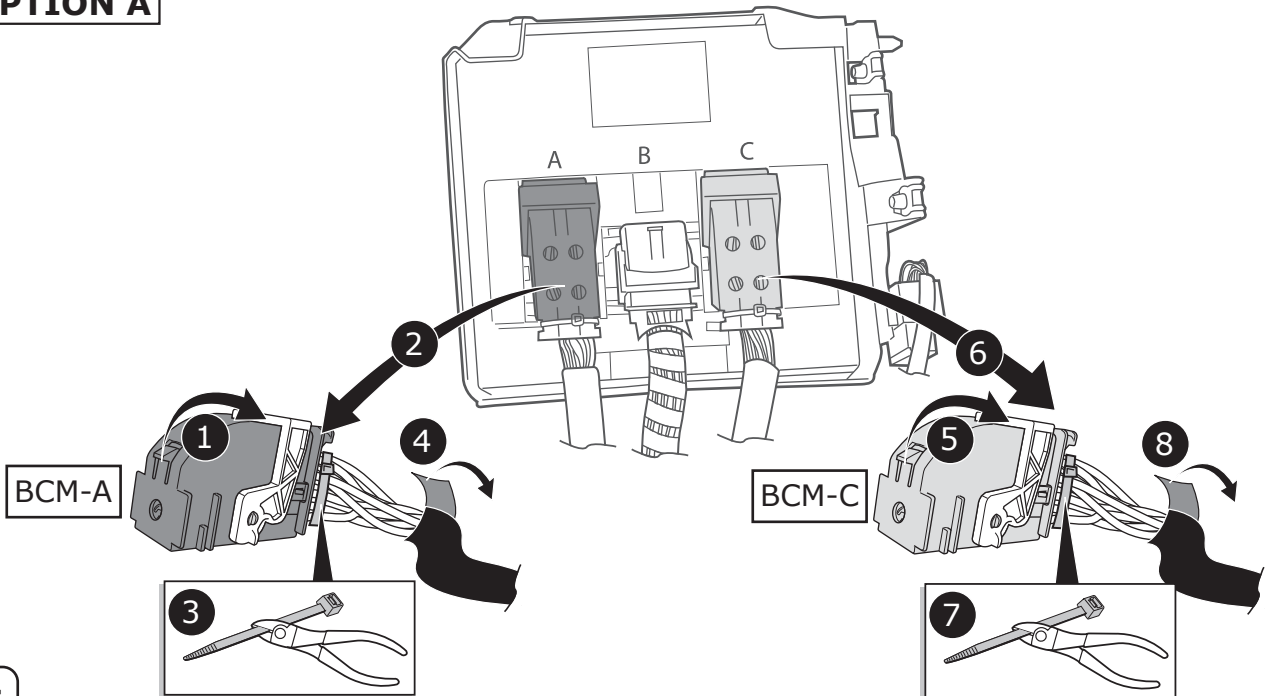

25

Vehicles **without** trailer preparation

CANbus  
**OPTION A**

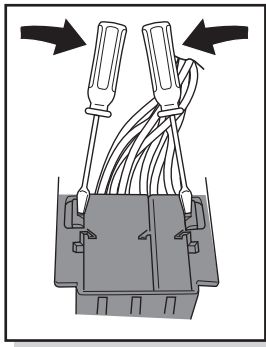

BCM-A

1

2

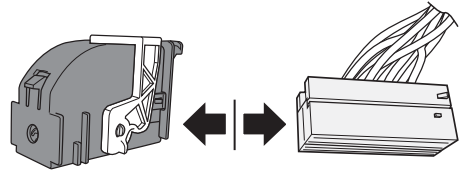

3

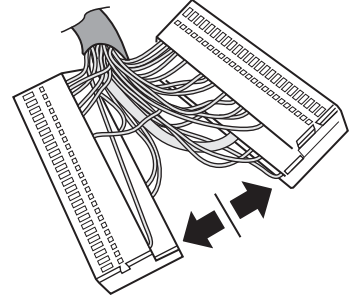

26

Vehicles **without** trailer preparation

CANbus  
**OPTION A**

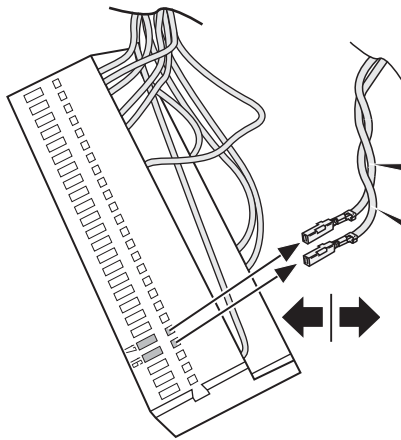

BCM-A

**CAN L** Orange/Brown  
Pos. 17

**CAN H** Green or Pink  
Pos. 16

Can-bus  
Datawire

27

Vehicles **without** trailer preparation

CANbus  
**OPTION A**

**CAN L** Orange/Brown  
Pos. 1

**CAN H** Green or Pink  
Pos. 2

BCM-A

Orange/Brown  
Pos. 1

1

3

L1

Orange/Green  
Pos. 2

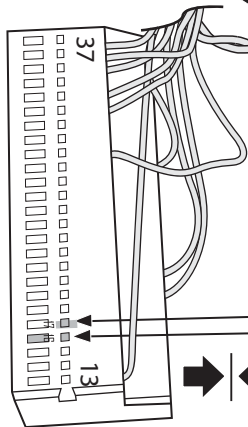

Orange/Brown  
Pos. 17

Orange/Green  
Pos. 16

Can-bus  
Datawire

L2

28

Vehicles **without** trailer preparation

CANbus  
**OPTION A**

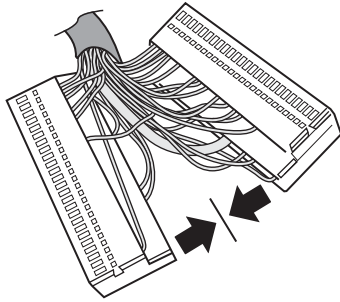

1

BCM-A

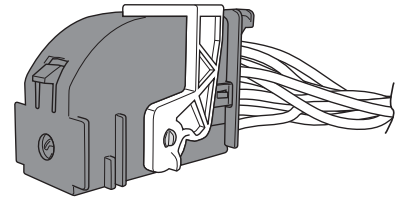

2

29

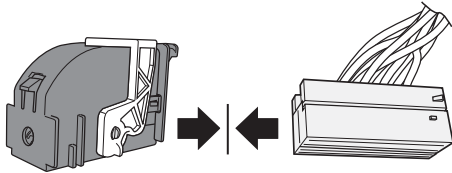

Vehicles **without** trailer preparation

CANbus  
**OPTION A**

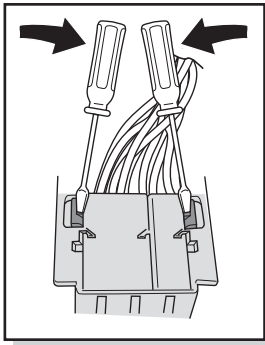

1

2

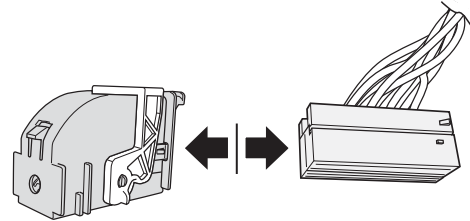

3

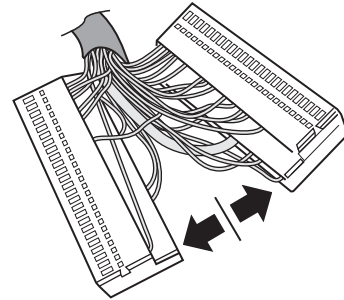

30

BCM-C

Vehicles **without** trailer preparation

CANbus  
**OPTION A**

BCM-C

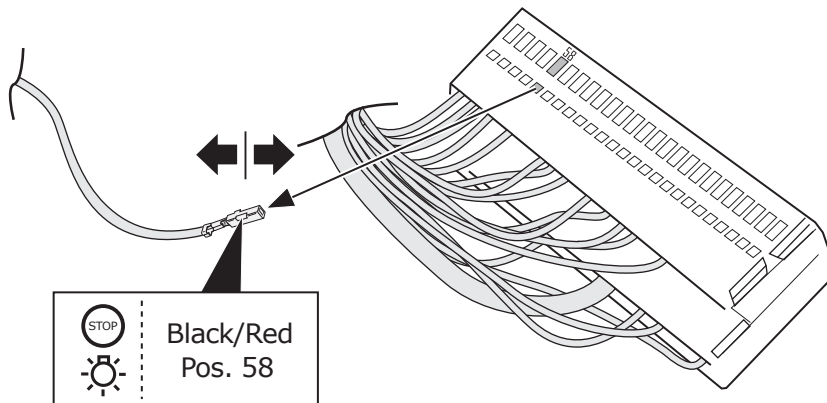

31

Vehicles **without** trailer preparation

CANbus  
**OPTION A**

LOCK

BCM-C

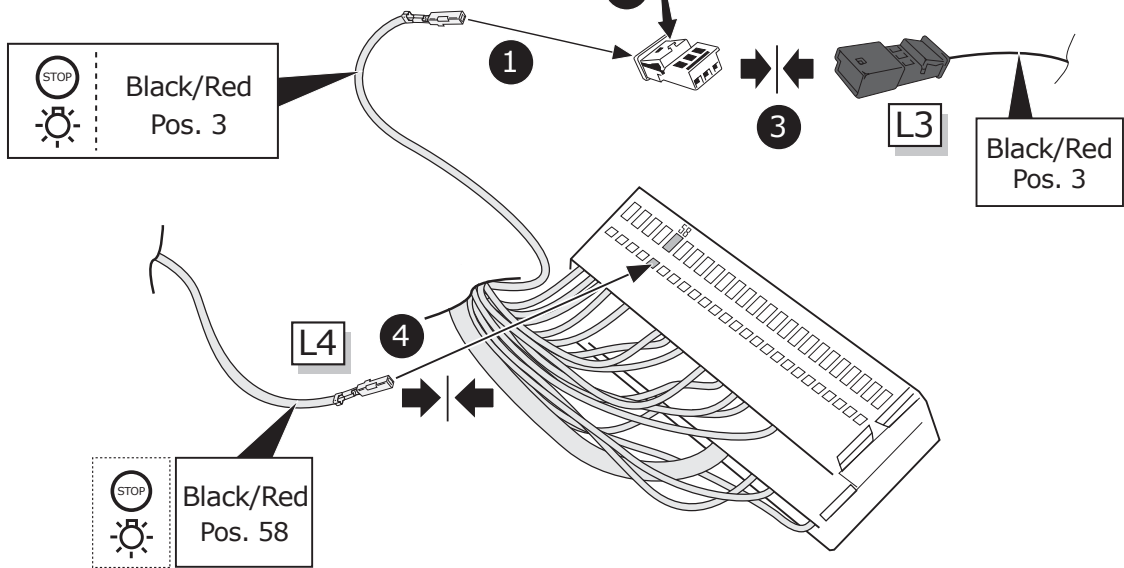

32

Vehicles **without** trailer preparation

CANbus  
**OPTION A**

BCM-C

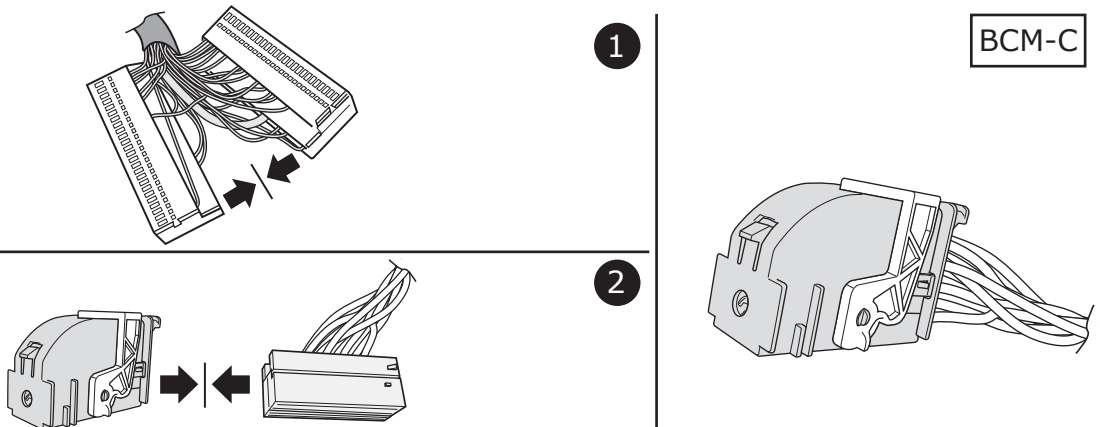

33

Vehicles **without** trailer preparation

CANbus  
**OPTION A**

**Body Control Module**

BCM-A

BCM-C

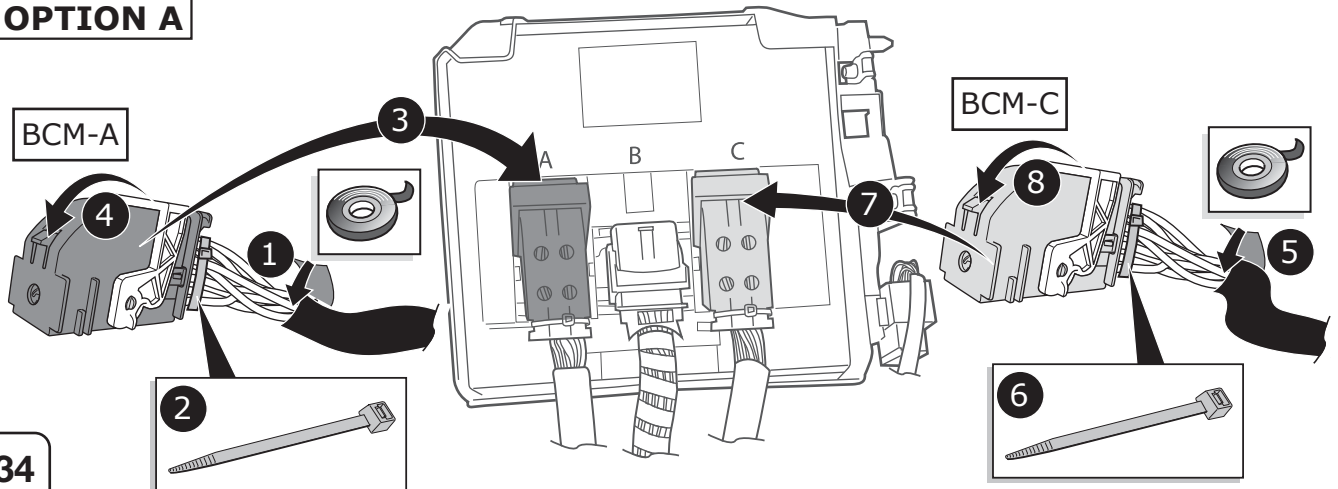

34

Vehicles **without** trailer preparation

CANbus  
**OPTION B**

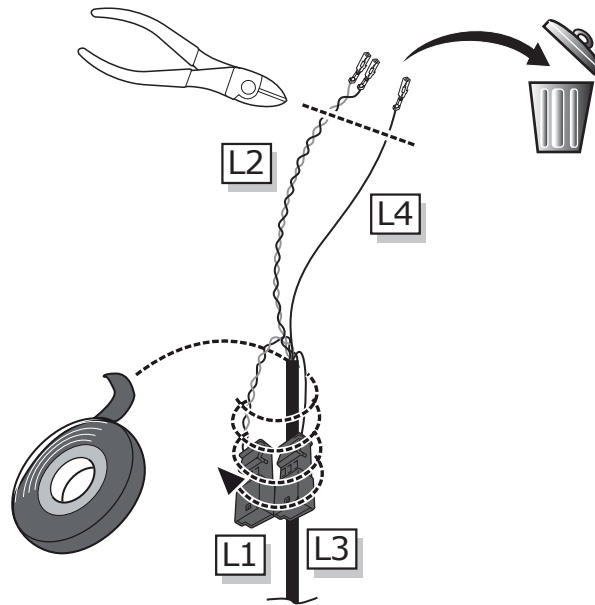

35

Vehicles **without** trailer preparation

CANbus  
**OPTION B**

**Body Control Module**

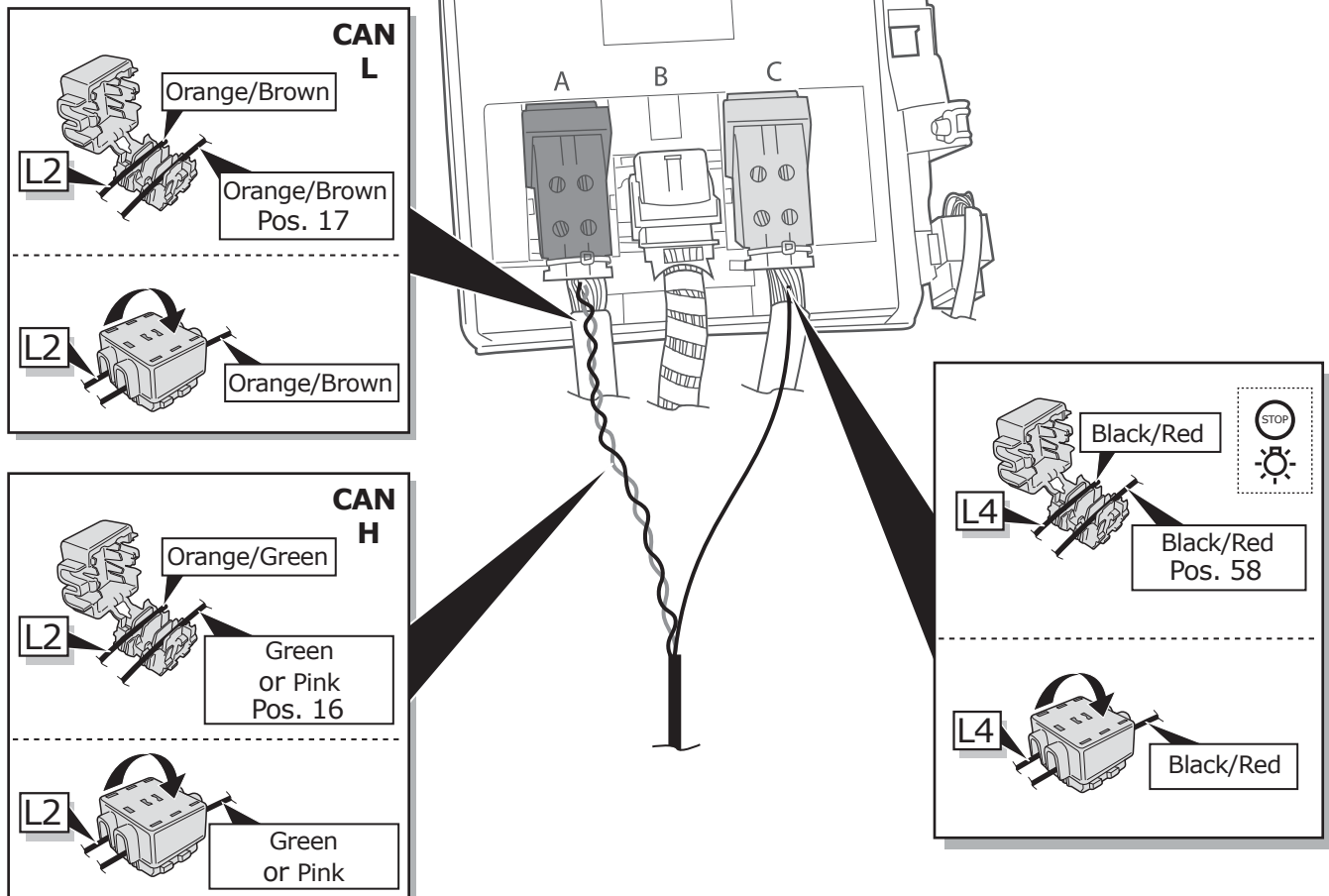

36

Vehicles **without** trailer preparation

**Fuse box option A**

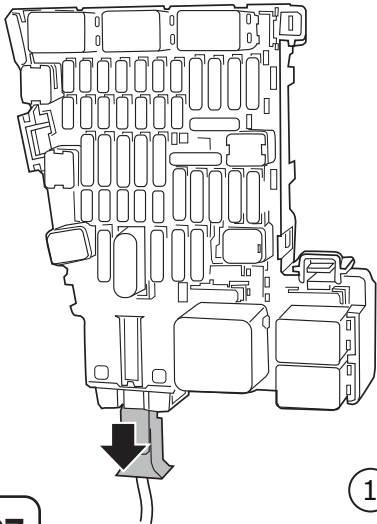

1

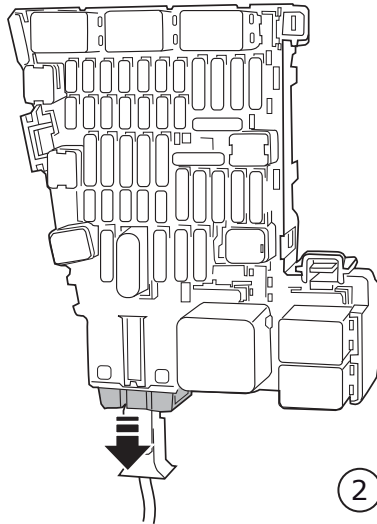

2

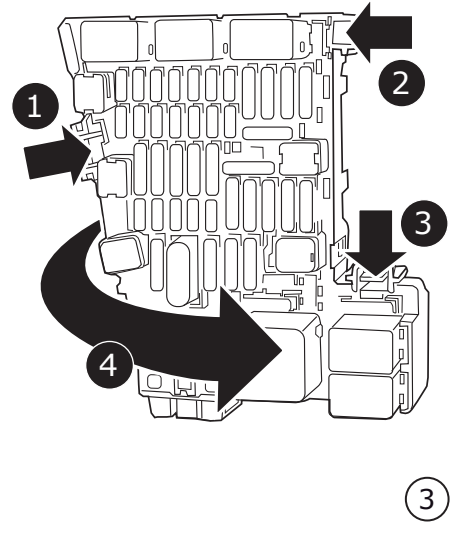

3

37

Vehicles **without** trailer preparation

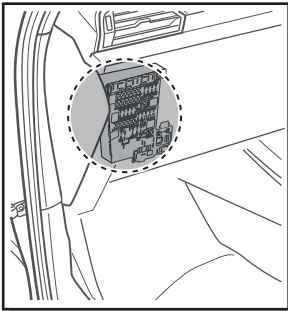

Red/Blue  
Pos. 28

U

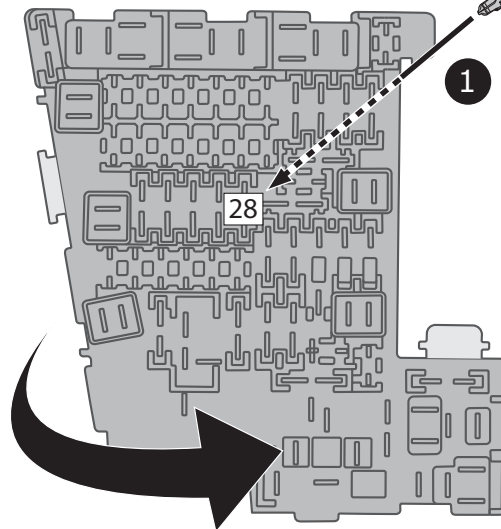

1

2



20 Amp.

Pos. 28



+30

38

Vehicles **without** trailer preparation

Fuse box option B

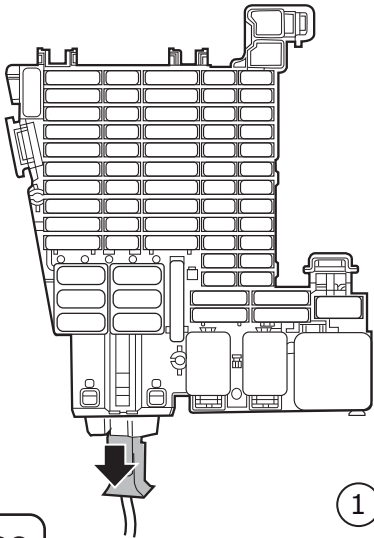

1

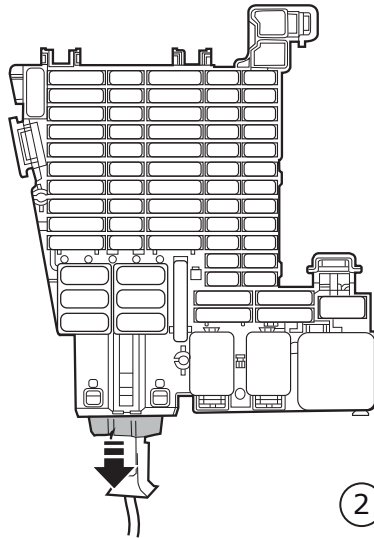

2

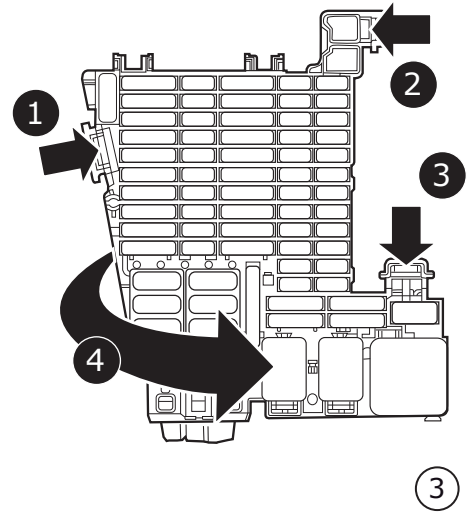

3

39

Vehicles **without** trailer preparation

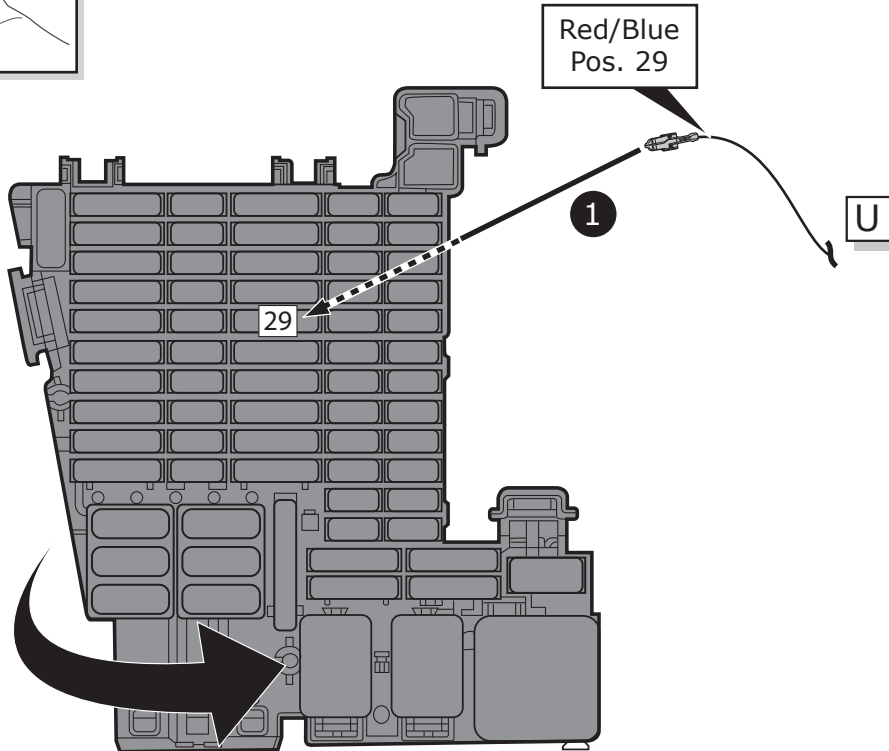
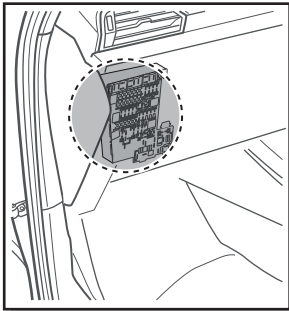

Red/Blue  
Pos. 29

1

29

U

2

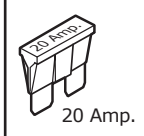

Pos. 29

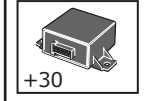

40

### Reverse signal preparation

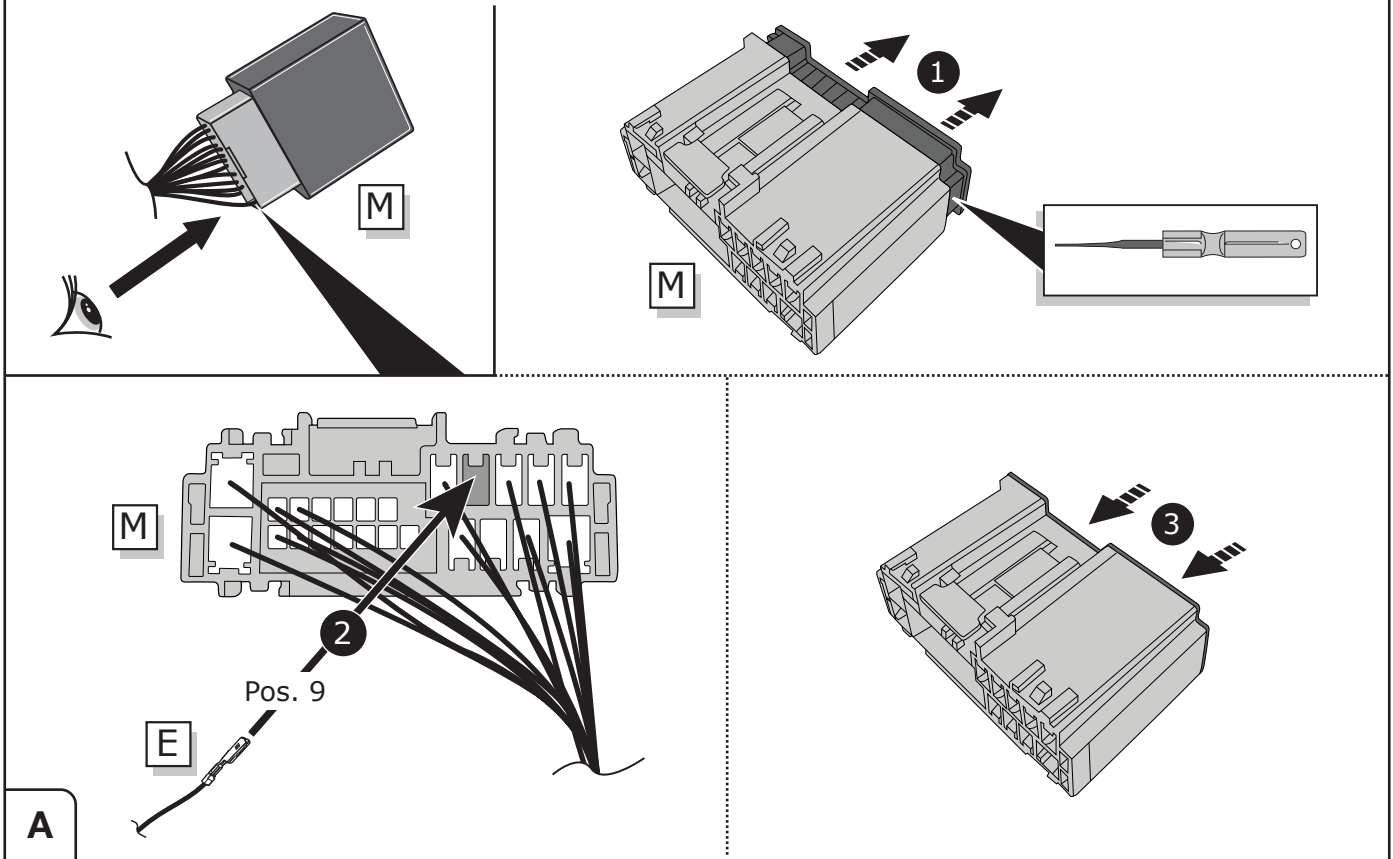

### Reverse signal preparation

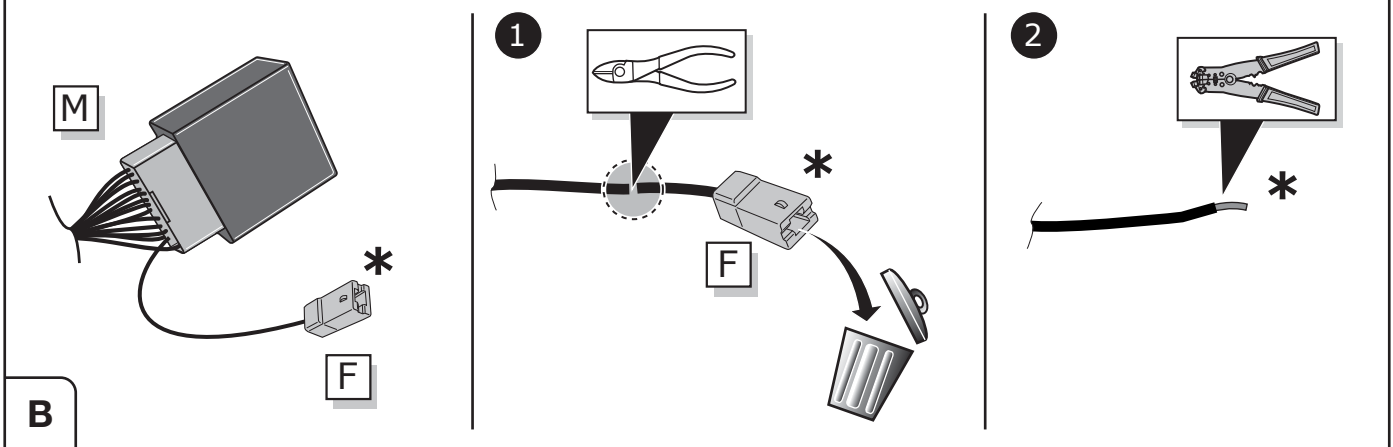

### Reverse signal preparation

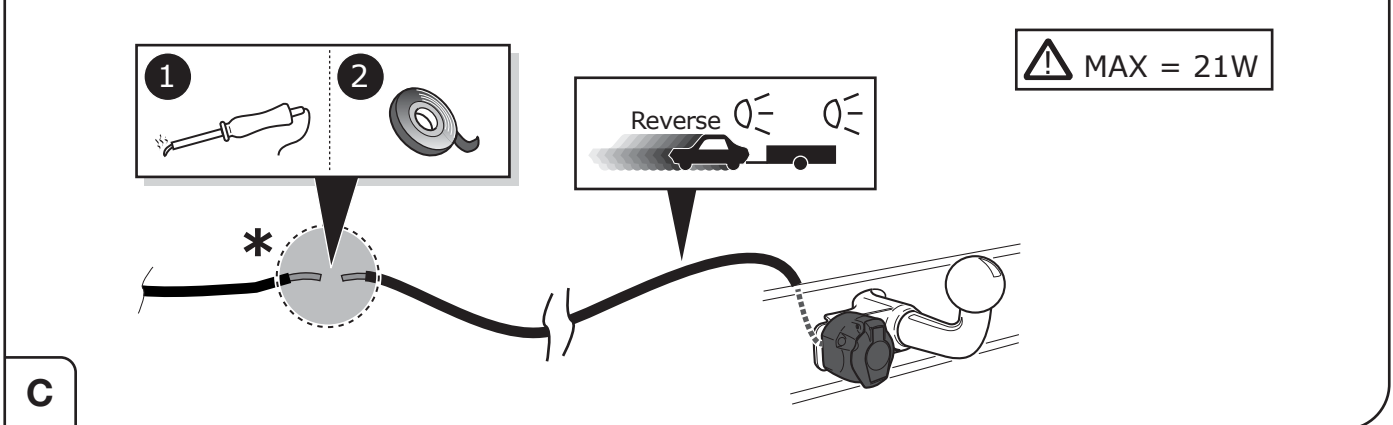

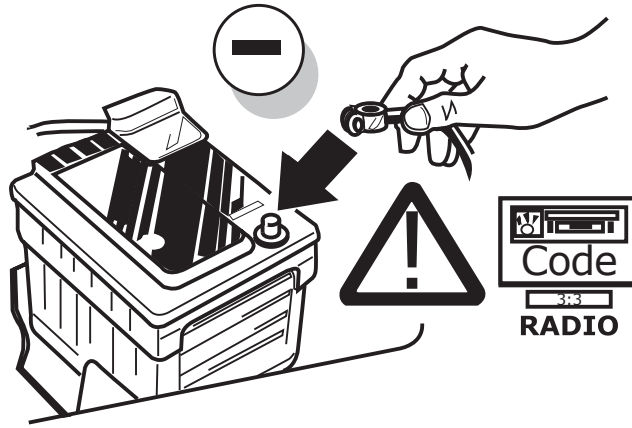

41

Optional

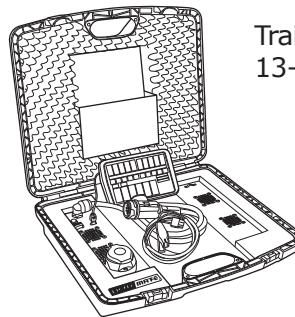

Trailer Simulator for 7- and 13-pin Sockets

42

### Duplex-Mode 1 - With Coding (read/write)

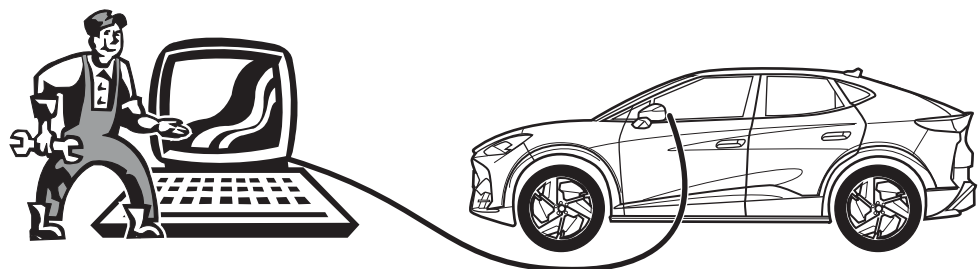

#### Diagnostic services and methods (local offline):

##### Please note:

Always use the latest diagnostic version!  
The vehicle to be coded must be supported by the diagnostic service provider and already be implemented in the diagnostics version!  
Please contact your diagnostic service provider in case of any question.

##### ATTENTION!

Model year 2021 vehicles are equipped with a so-called vehicle diagnosis protection (SFD). Make sure that access to locked on-board control units is granted by the diagnostic system.  
Possible diagnostic service providers:

- ODIS (page 22)
- JIFELINE

43

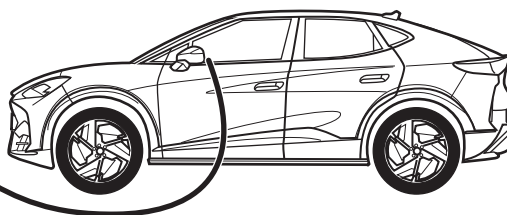
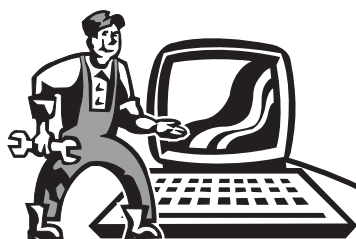

# Complete Diagnostics

remote diagnostic & coding solutions

Call Hotline +44 (0)1952 608 750 - Option 4

## CODING WITH ODIS

### Please note:

The procedure described below for encoding and enabling the trailer mode only serves for a general orientation and can vary greatly depending on the model (motorisation / equipment). If necessary less or further control units will have to be adapted.

**After connecting to ODIS, the "69 trailer function" controller has to be set to encoded in the target installation list.**

The following may be necessary in the further course of work:

### **EZE\_09 (electronic central electric controller):**

Diagnosis  
(possible login code: 31347)  
Networking plan  
Controller self-diagnosis  
Encode  
Trailer connection device >installed  
or: hitch\_ecu >installed

### **Alternative encoding EZE\_09 as follows (MY 2017 >>):**

Self diagnose control unit  
Access authorization >31347  
Adjustment  
Integration  
Trailer control unit > installed

### **ZKS\_46 (Central module convenience system)**

trailer monitoring >put on active  
trailer control unit >installed

### **SWA\_3C (Lane Change Assist)**

ECU for draw bar >with ECU for draw bar

### **SW2\_CF (Lane Change Assist2)**

ECU for draw bar >with ECU for draw bar

### **SCH\_17 (Dash panel insert)**

Trailer >yes

### **RFK\_6C (reverse camera system)**

equipment\_ahk >installed

### **STF\_74 (chassis control system)**

Trailer >installed

### **EPH\_76 (PDC controller)**

Trailer >trailer device can be removed manually

### **DIS\_13 (controller distance control)**

(possible login code: 20103)  
Control module for towing sens >installed

### **Alternative encoding DIS\_13 as follows:**

Self diagnose control unit  
Access authorization >20103  
Encoding  
Binary encoding  
**Byte 3**  
Binary >xxxx1xxx  
or Hex >+8

### **03 Brake electronics**

Access authorisation > 61378  
Adjustments  
Trailer stability >Active

### **FFF\_A5 (front sensor system controller)**

AAG >coded

### **HDE\_6D (boot lid electronics controller)**

Trailer >installed

### **Encoding AST\_7E (Driver display unit)**

Encoding  
Trailer → on

### **Important note on encoding and activating in trailer mode**

The aforementioned settings are carried out in the vehicle's electrical system and saved locally. During general updates for the vehicle software (for example, within the scope of service or repair work), the settings may be overwritten and deleted under certain circumstances. In this case, the trailer mode activation has to be updated again locally after the update. Diagnostic information relating to the trailer mode that may appear during variance comparisons with the data saved in the manufacturer's works, may form the basis of the local activation.

**Functional test**

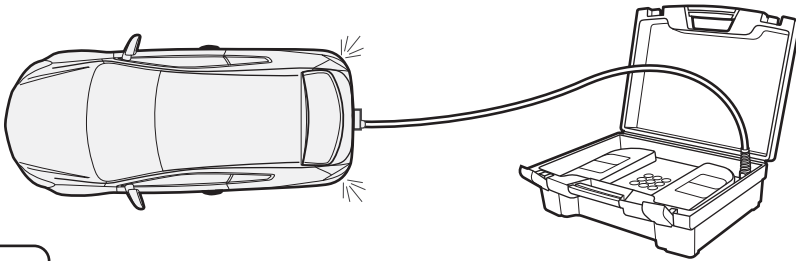
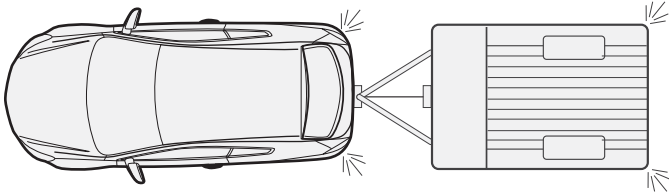
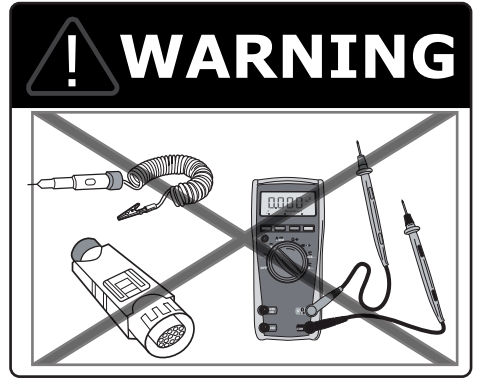
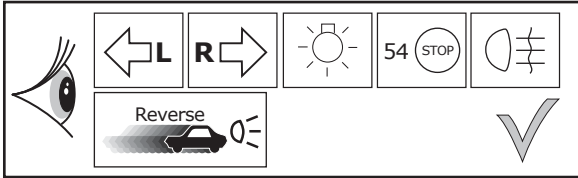

45

**Duplex-Mode 1 - With Coding (read/write)**

**INFO**

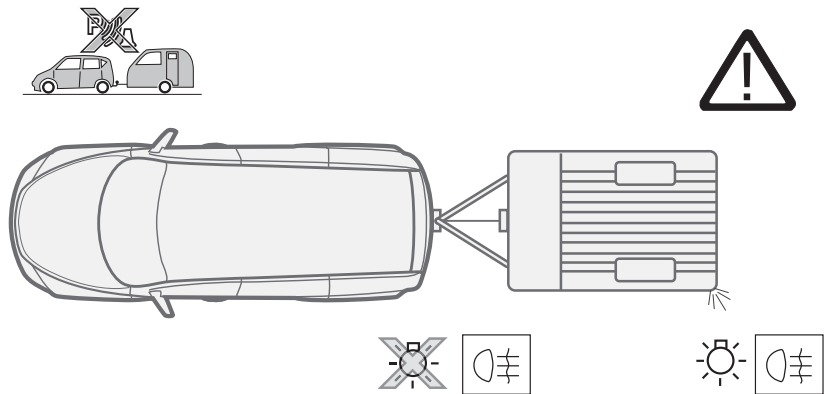
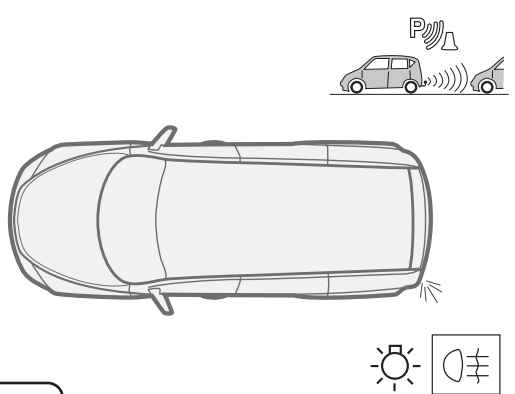
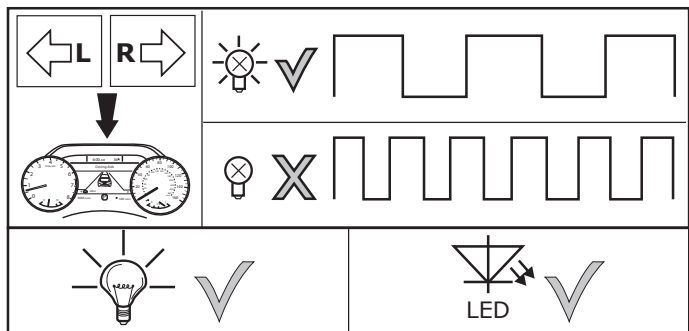
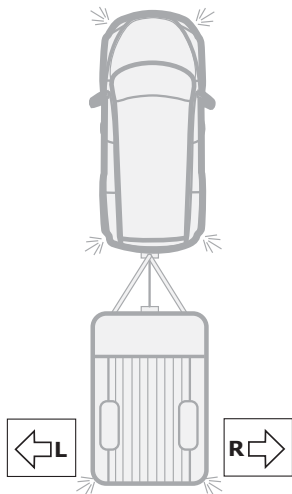

46



**Rear fog light cut-off is not supported!**



**PDC to be deactivated manually!**

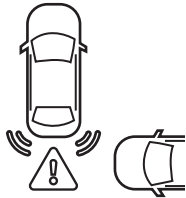

**Rear Collision Avoidance Systems to be deactivated manually!**

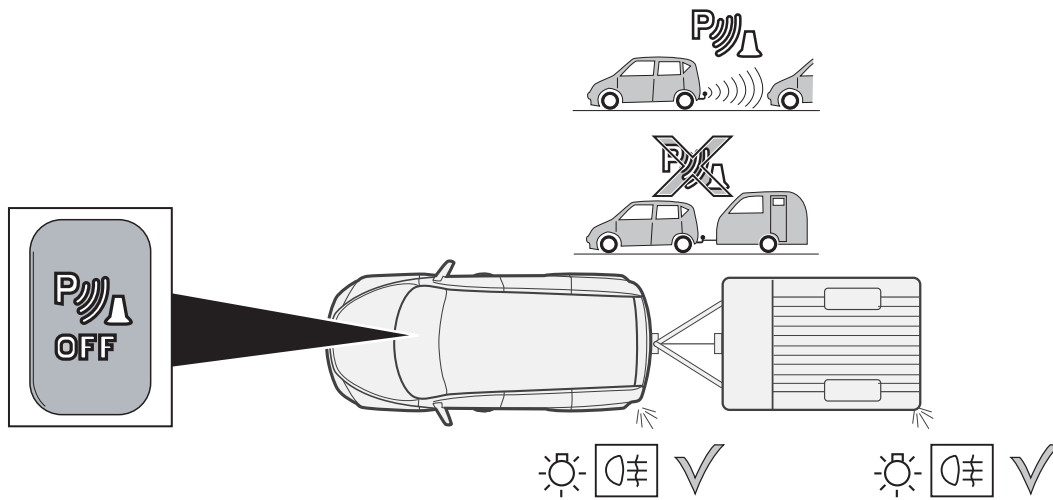

47

**INFO**

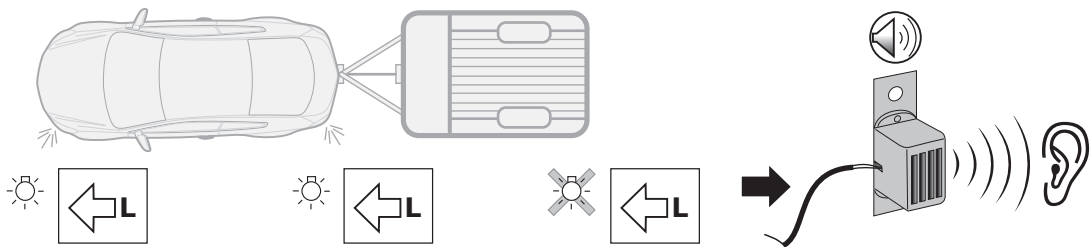
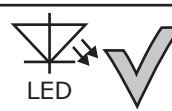
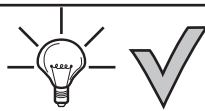

48

## How to change the Duplex-mode if required:

### INFO

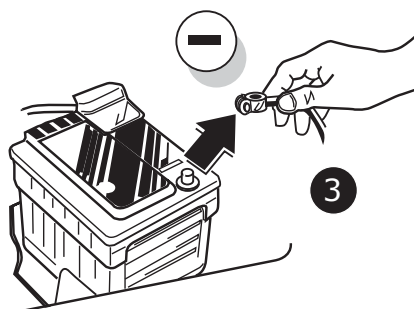
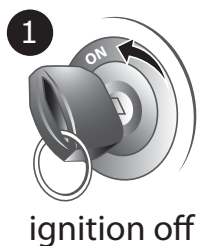
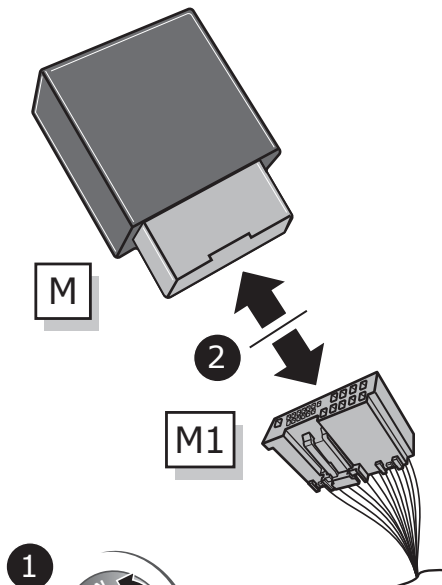

1. Turn off ignition
  2. Disconnect trailer module M from harness M1
  3. Disconnect battery
  4. Set up requested Duplex mode:
    - Disconnect D and attach buzzer (B) for read-only mode
    - Connect D and remove buzzer (B) for read/write mode
- Connect trailer module M to harness M1
  - Connect battery
  - Turn on the ignition and run a full test
  - Coding may need removing or adding depending on Duplex mode selected

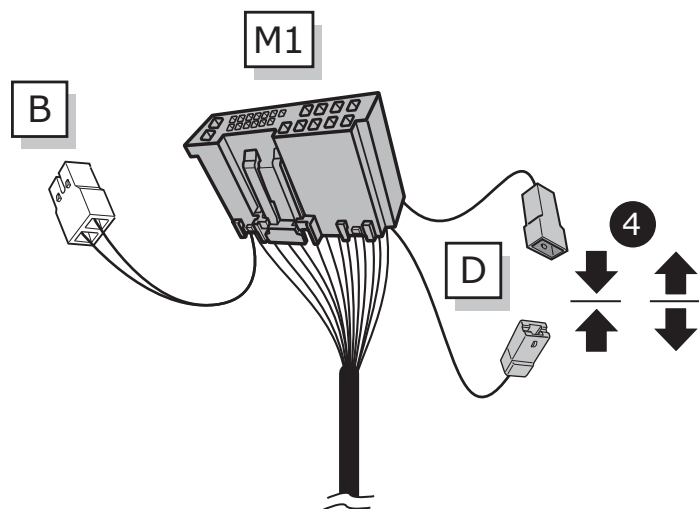

49

The following light functions for the trailer are **not supported** by all towing vehicles **with DRL circuit**:

- Rear lights
- Side lights
- Numberplate lights

The **taillights or dimmed headlights** **must be switched on** to activate this function!

50

**Optional**

### Adapter socket



51

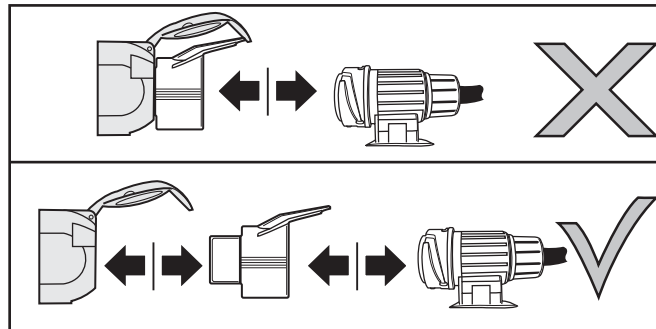
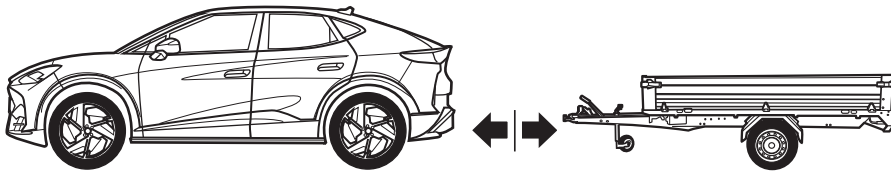

52

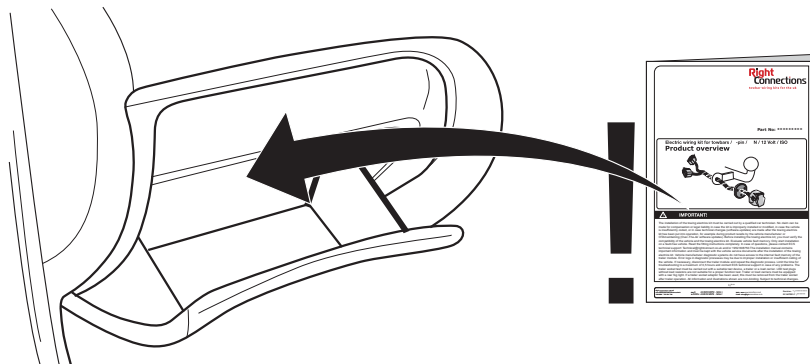

53

## SOCKET CONNECTION

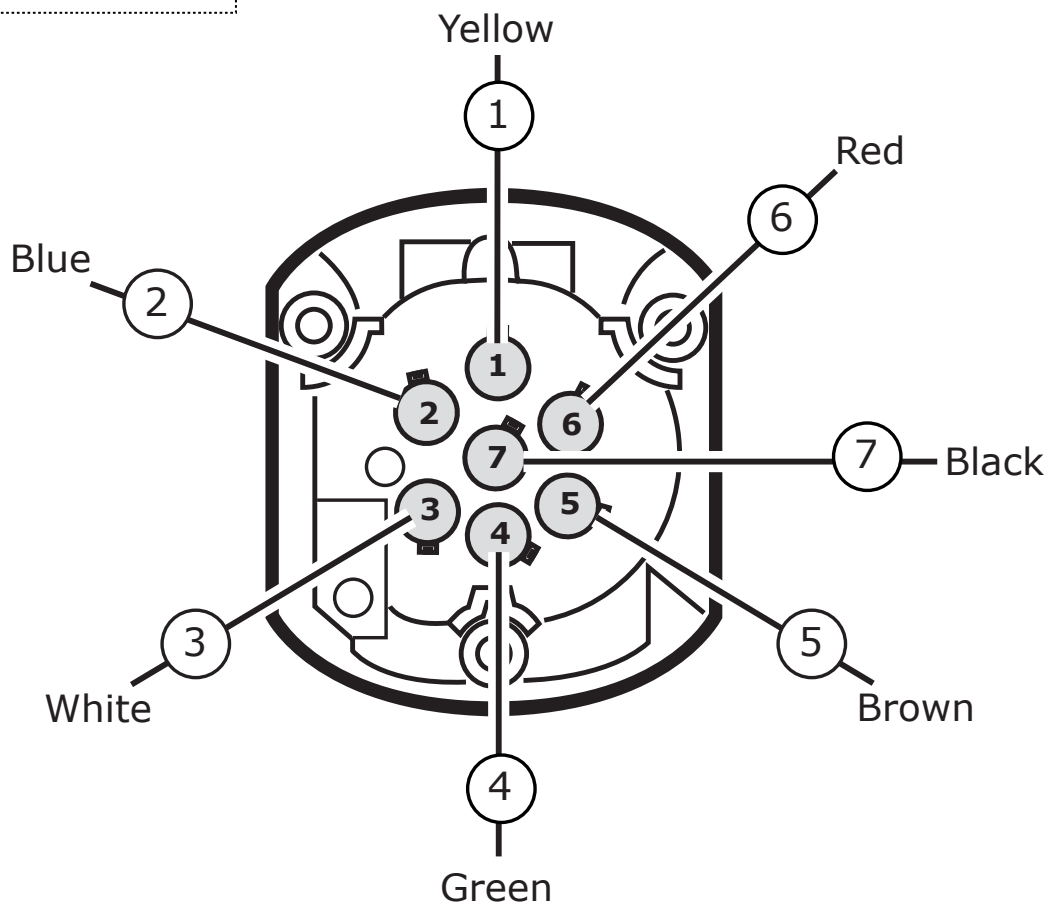
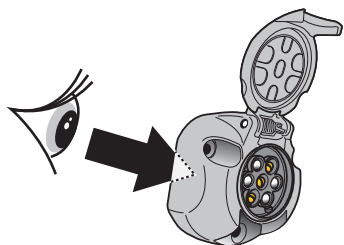

## SOCKET CONNECTION

DIN/ISO 1724							
	1/L	2	3/31	4/R	5/58-R	6/54	7/58-L
Pmax	21W	42W		21W	52W	3x21W	52W
Colour	Yellow	Blue	White	Green	Brown	Red	Black