

Right Connections

towbar wiring kits for the uk

VAUXHALL

Astra K 5-doors 10/2015 >> 01/2022
Astra K Sports Tourer 04/2019 >> 01/2022

Part No: VA-007-13

Electric wiring kit for towbars / 13-pin / 12 Volt / ISO 11446 Fitting instructions

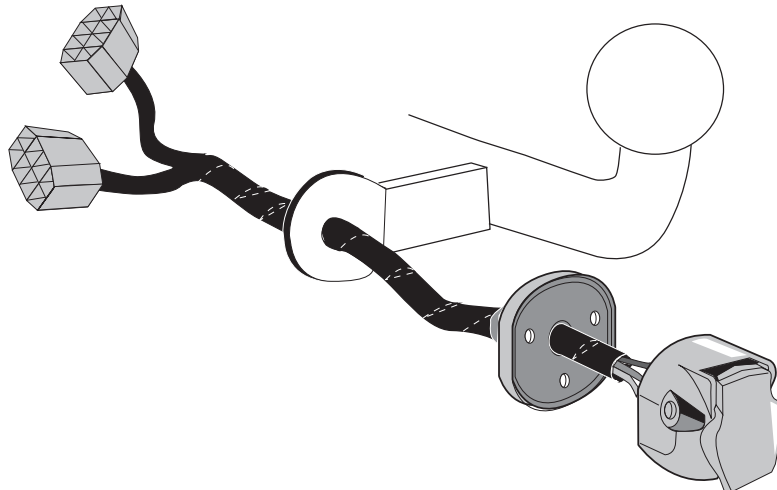

IMPORTANT!

This electric kit has to be installed by a professional workshop or a suitable qualified person. The installation instructions must have been read and fully understood before the start of any installation. Please contact your wiring kit provider or the hotline shown in the footer should you need assistance!

Make sure the vehicle is approved/homologated by the manufacturer to tow a trailer!
 Also please check that there is a definite compatibility between this vehicle and the electric kit!

Following the installation of the electric kit, the fitting instructions should be kept together with the vehicle service document and vehicle handbook. The fitting instructions contain important information relating to the use and function of the towing kit as well as for any diagnostic or activation process, that might have to be repeated in the future (e.g. after the performance of a vehicle software update).

All warranty claims will be forfeited if the electric kit or components contained therein are used incorrectly or modified. If a towing socket adaptor has been used to connect to the trailer or bike rack, this must be removed from the trailer socket once the trailer or bike rack has been disconnected.

If the trailer or bike rack is not equipped with a rear fog lamp, depending on the towing vehicle type, the correct function of the towing kit cannot be guaranteed. In such cases, a rear fog lamp should be retro fitted.

This towing electric kit will not be covered under warranty if any technical or electrical modifications or software updates have been performed by the vehicle manufacturer after the initial commissioning of the kit. That applies especially to modifications or updates which may cause malfunctions in the trailer socket or any other part of the trailer electrical equipment!

Depending on the type of trailer module used in this electric kit, diagnostic interrogation with the vehicle's electrical system may be limited or will not function. The error memory inside the trailer module may not be able to be accessed by vehicle manufacturers diagnostic system.

Error logs relating to the trailer electrical equipment, that may be generated in the vehicle manufacturers diagnostic system as a result of a test procedure, may be due to the incorrect installation of the towing electric kit or the false activation of the trailer module.

We always recommend whenever possible, the following troubleshooting process:

- An analysis of the vehicle's error memory and possibly clearing of all faults before the start of the installation!
- Try disconnecting the trailer module from the towing harness and re-start the fault clearing process!
- If in doubt, limit the time for troubleshooting to a max of 0,5 hours and call our Technical Support Team!

Please follow our instructions carefully and always test the towing electrics using a true lighting board or a specifically designed bulb tester. If an LED tester is used, ensure it is equipped with correct load resistors or malfunctions will occur!

This instruction is subject to changes and we reserve the right to make changes to design, colour etc.

All of the data and illustrations may not be an exact representation but the text contained in this instruction must be observed!

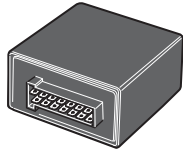
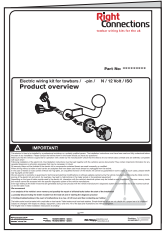

M

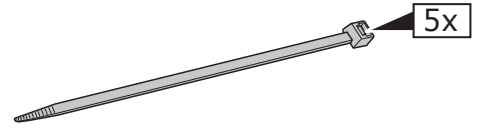
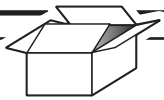

5x

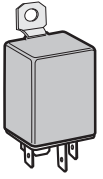

R

U1

U2

G

B

C

R1

M1

X

A

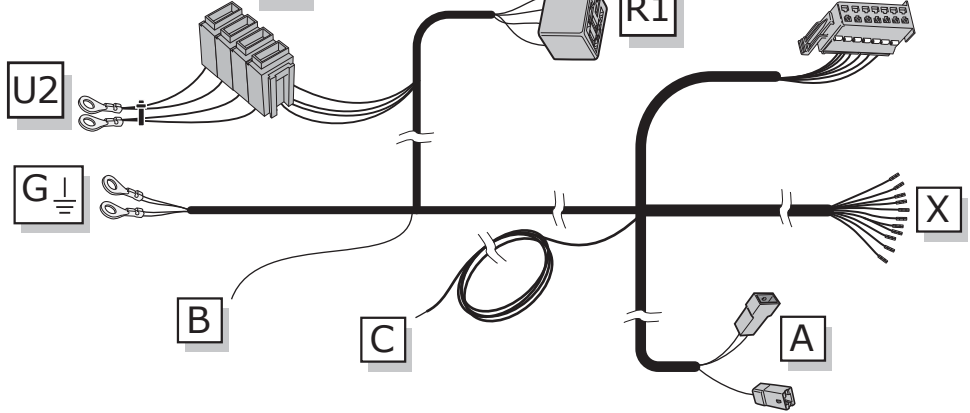
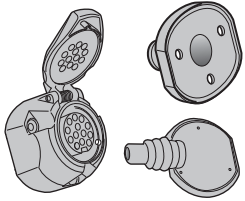

3x



3x



3x

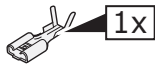

1x

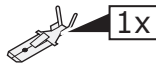

1x

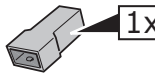

1x

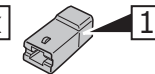

1x

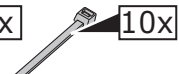

10x

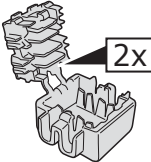

2x



3x



4x

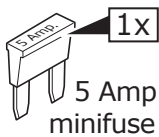

1x

5 Amp.
minifuse



1x

15 Amp.
minifuse

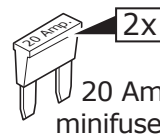

2x

20 Amp.
minifuse

Option 2



S

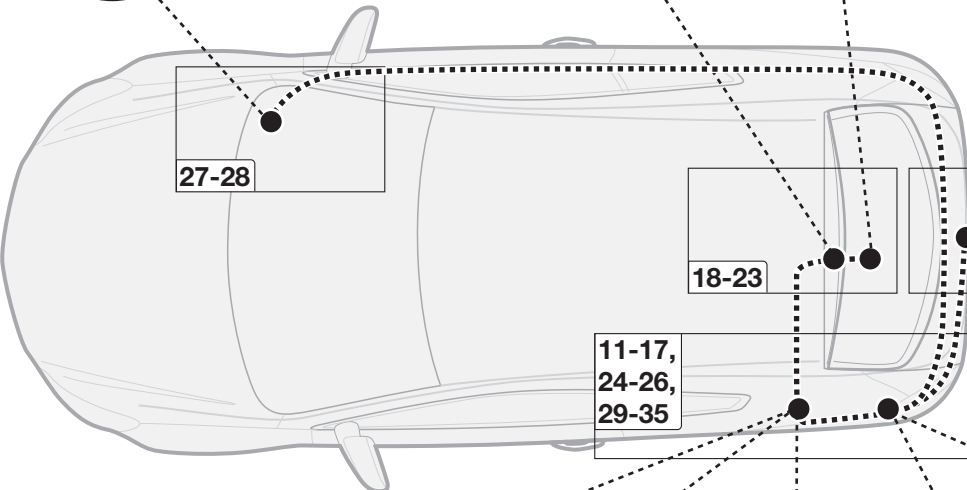

27-28

18-23

4-10

11-17,
24-26,
29-35

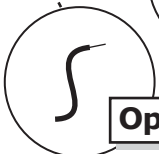
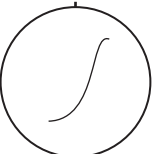
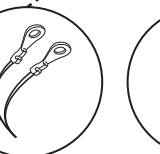

Option 1

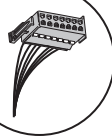

SYMBOL EXPLANATION

	Left (58-L) respectively Right (58-R) tail light
54	Stop light (54) / high mounted, third stop light (54)
	Turn signal indicator left
	Turn signal indicator right
	Rear fog light(s)
Reverse	Reversing light(s)
30+	Permanent power supply / 13pin socket, chamber 9
15+	Charging wire for trailer battery / 13pin socket, chamber 10
	Trailer / trailer recognition
B+ / 30	Permanent current power supply
	Ground or Earth (31)
	Ground connection battery terminal lug
	Positive connection battery terminal lug

	Cigarette lighter / accessory socket
	Loudspeaker / buzzer
	Park Distance Control
	Switch / source of function
	Connect together
	Disconnect
	Look at / See further information
	Look carefully at selected area
	Present / Occupied / OK
	Not present / Not occupied / Not OK
	Acoustic indication
	Attention / important advice
	Fuse / fuse capacity 20 Ampère

TOOLS

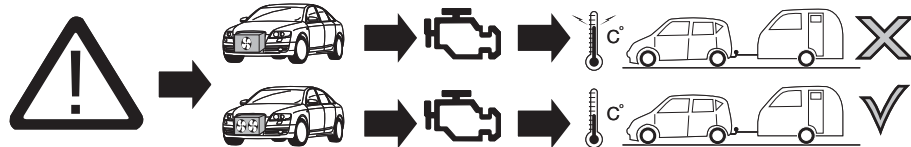
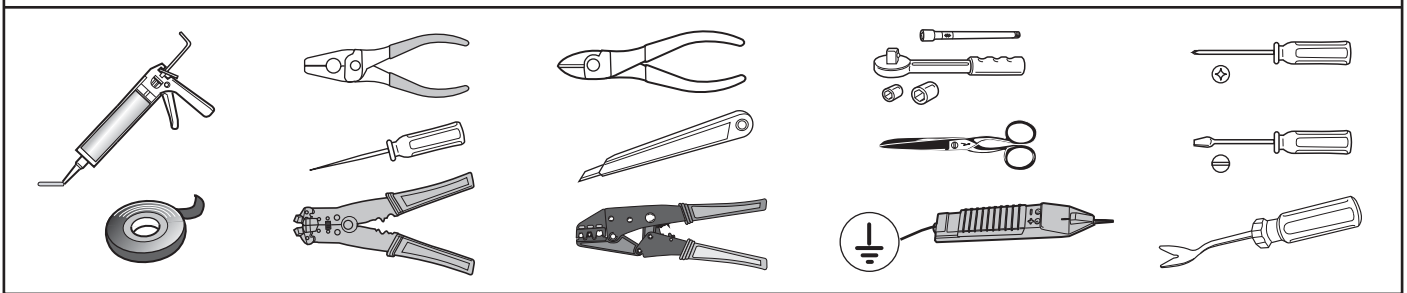

ATTENTION!

The vehicle's cooling capacity may have to be increased when retrofitting a trailer coupling! You must observe the manufacturer's instructions!!

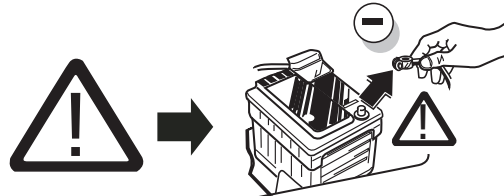

Note: It may be necessary to check if this vehicle has a stored radio code before disconnecting the battery!

ATTENTION!

In order to avoid mal-functions and damage to the vehicle's electrical system the earth terminal **must be disconnected** from the vehicle's battery **before starting work!**

Both the trailer module and the vehicle's control unit for the electrical system can be damaged during work on the data bus connections if the battery is not disconnected!

1 Please pay attention to the manufacturer's instructions when disconnecting and reconnecting the vehicle's battery!

5-doors

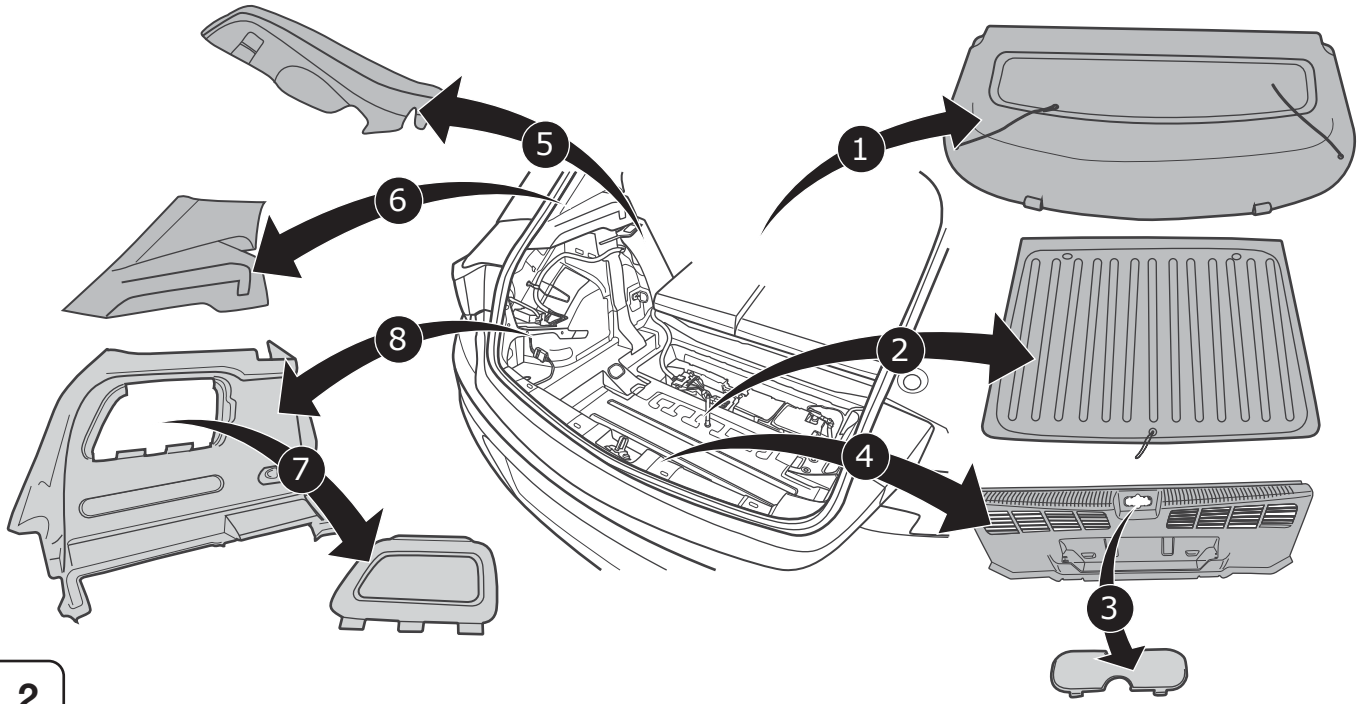

Sports Tourer

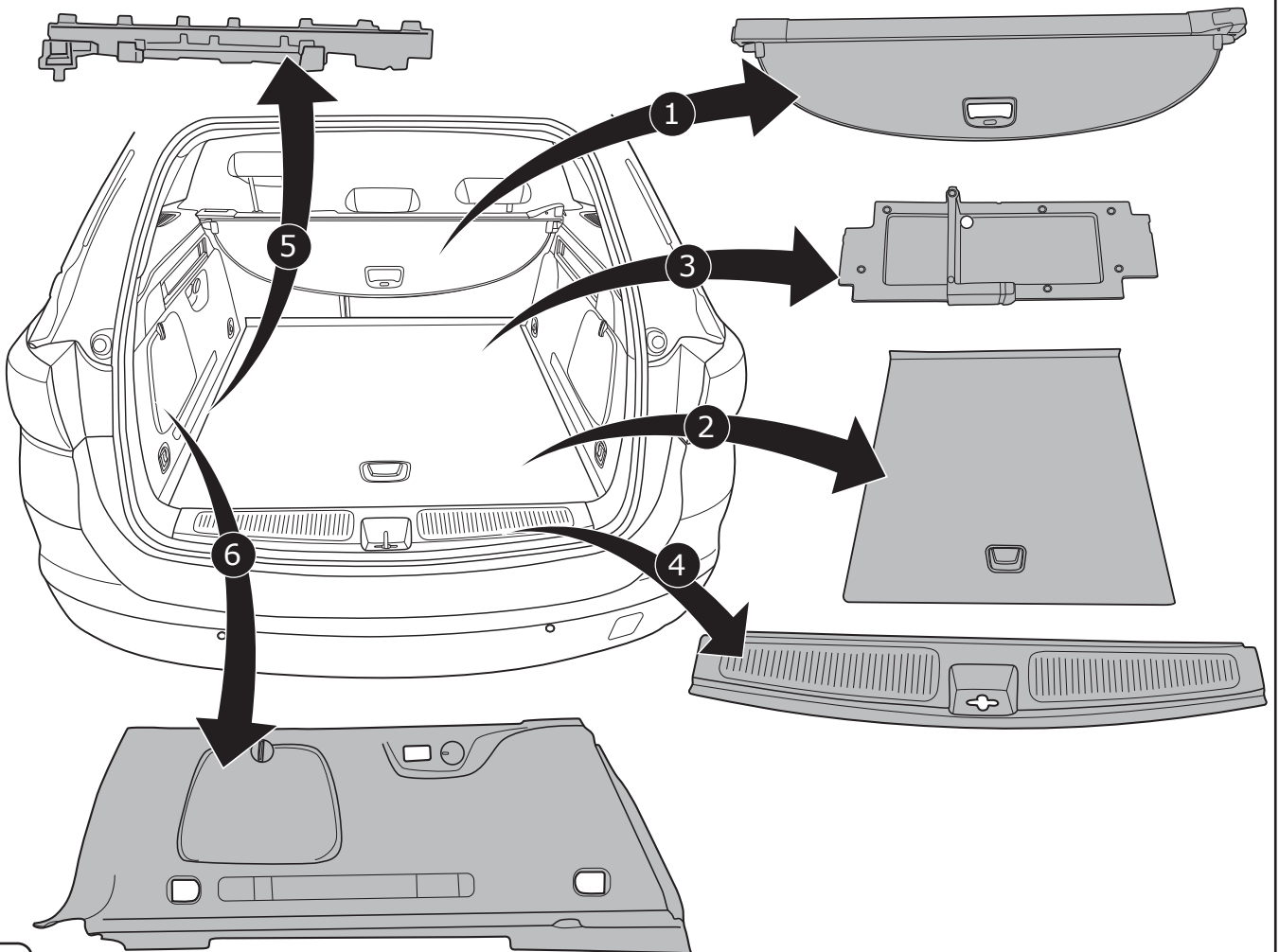

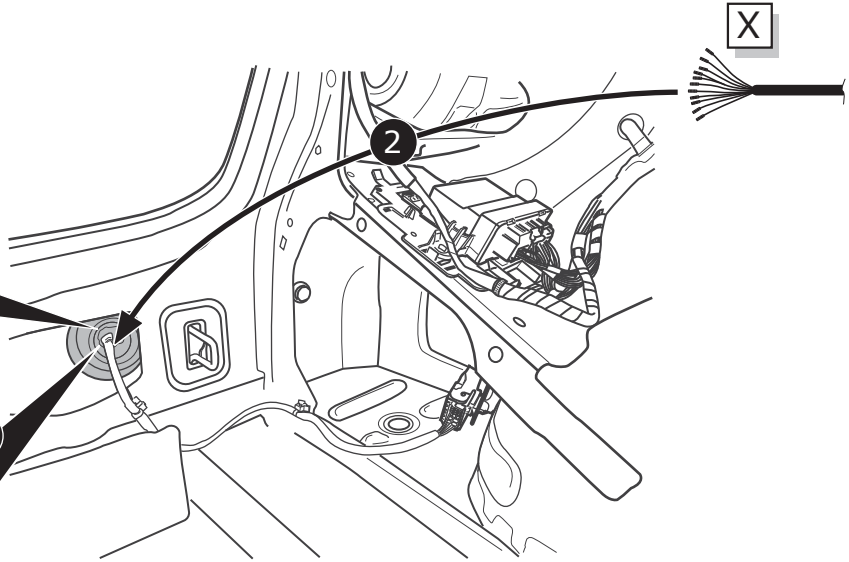
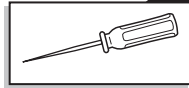
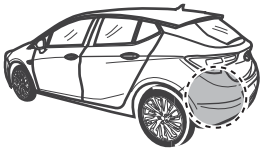

4

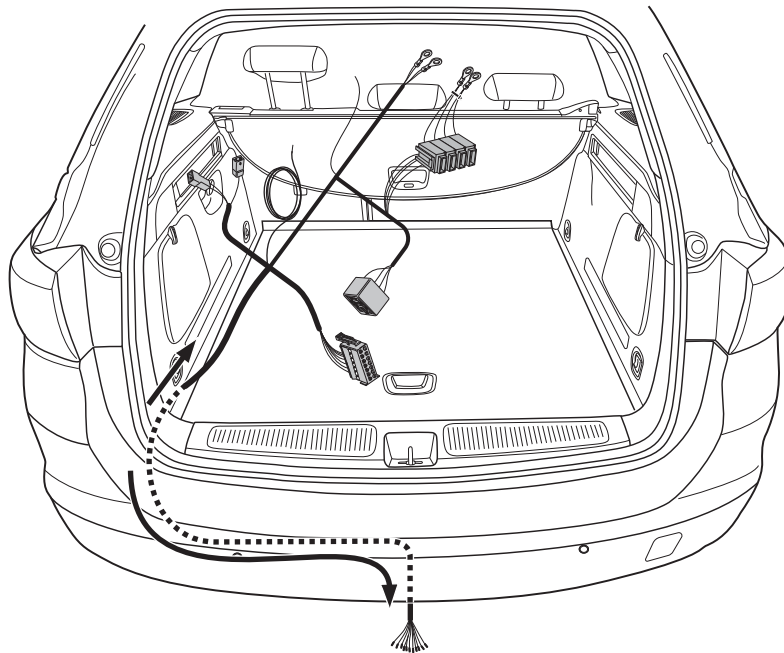

5

Option 1

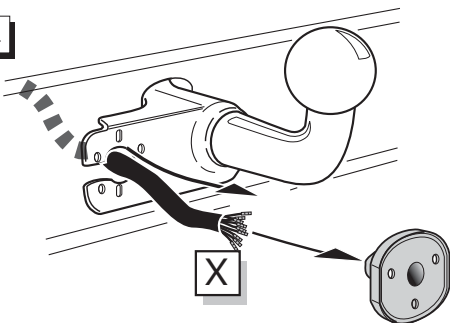

Option 2

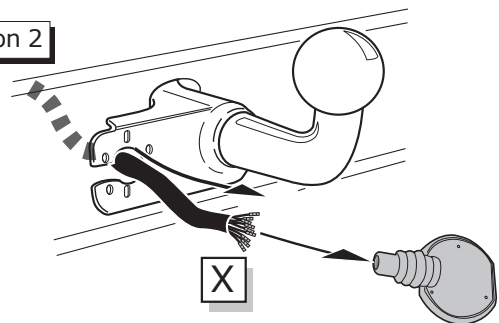

6

SOCKET CONNECTION



Page 20

7

Option 1

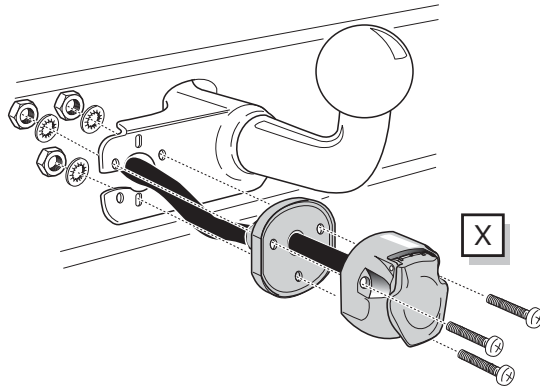

8

Option 2

1

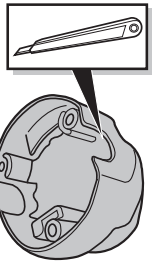

9

2

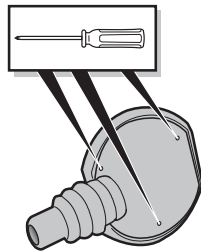

3

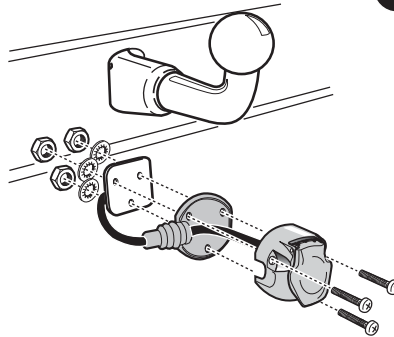

4

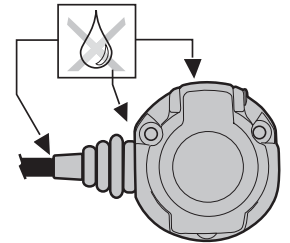

Option 2

1

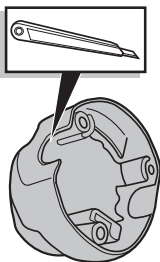

10

2

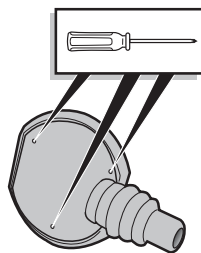

3

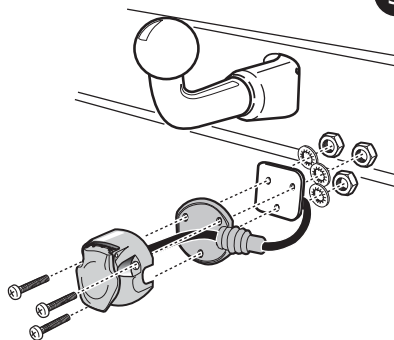

4

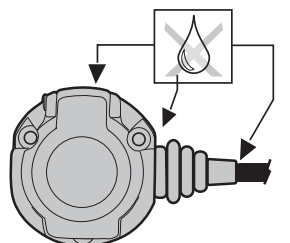

11

1

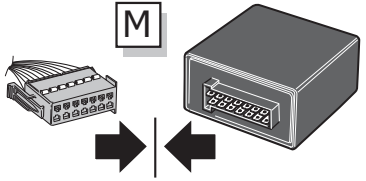

2

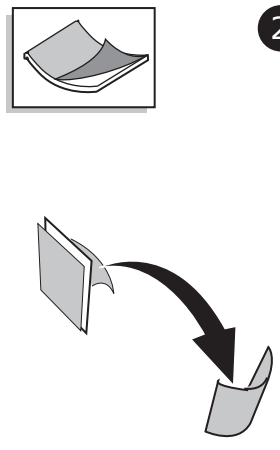

3

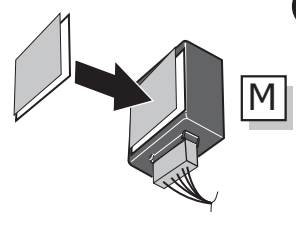

4

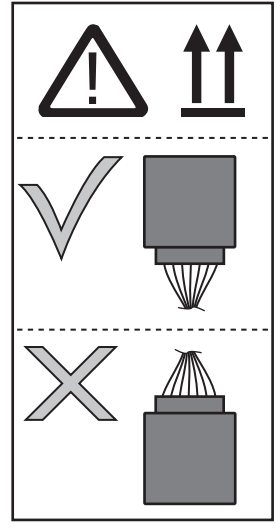
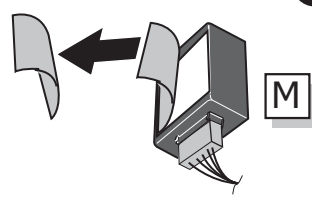

12

5-doors

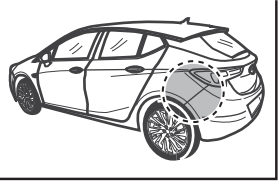

M

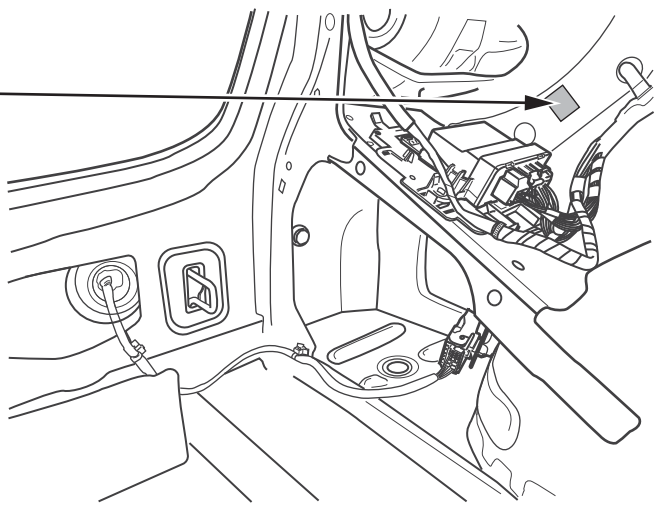
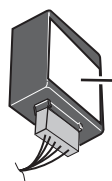

13

5-doors

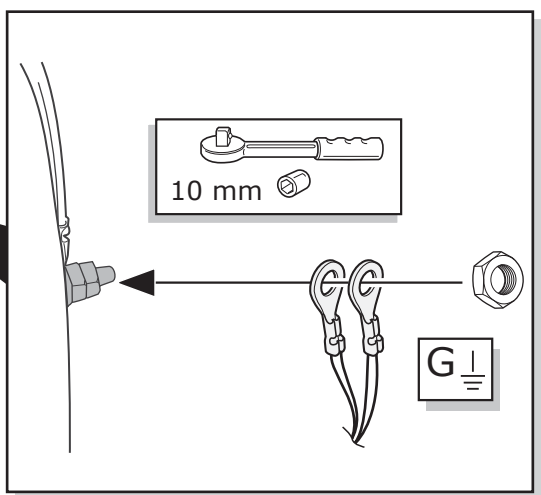
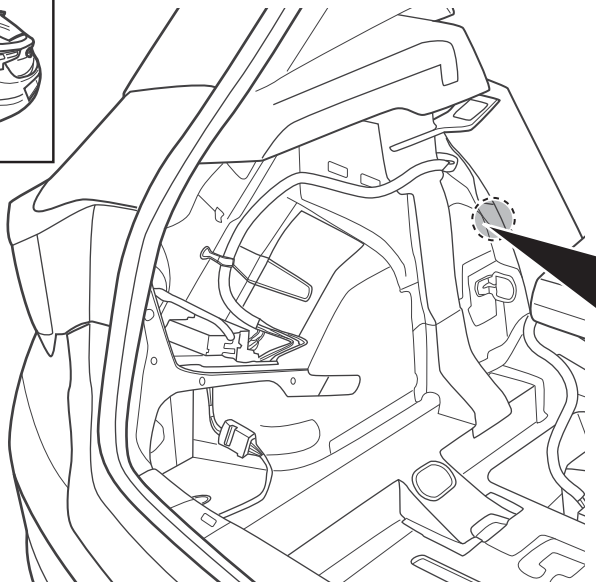
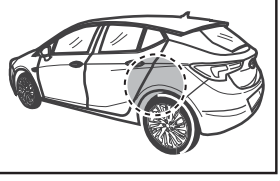

Sports Tourer

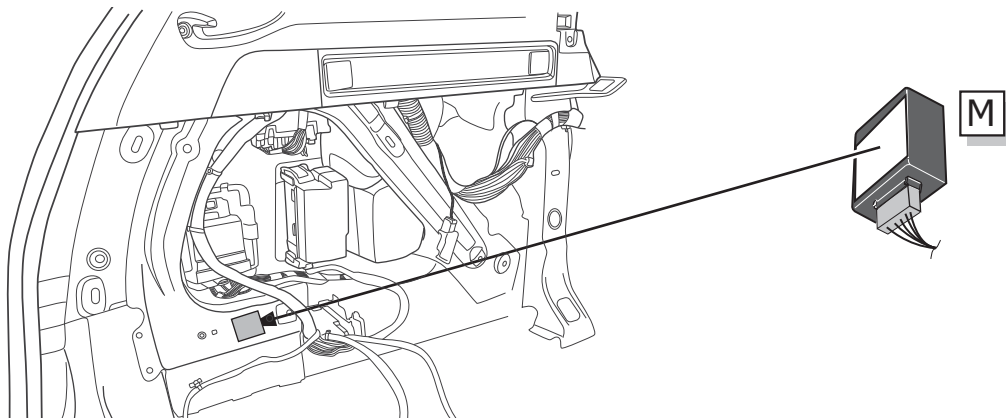
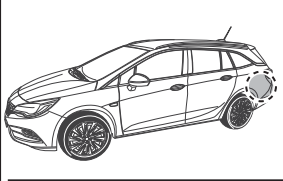

14

Sports Tourer

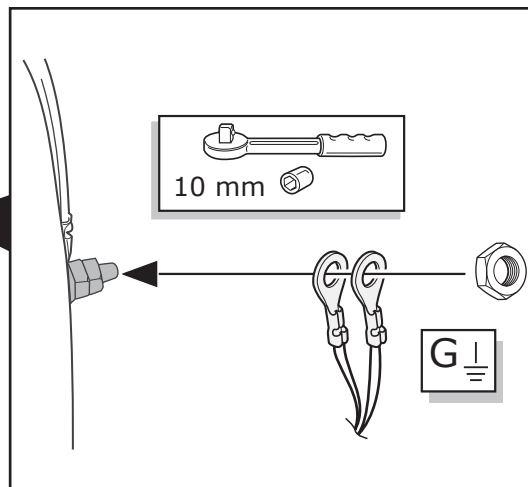
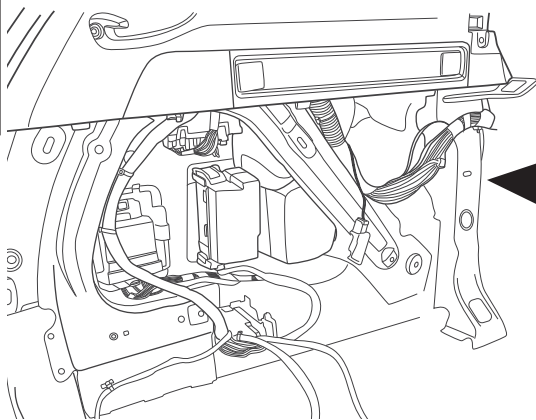
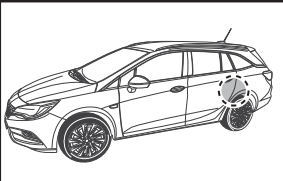

15

Option 1

MY 2020- 11/2019 >>

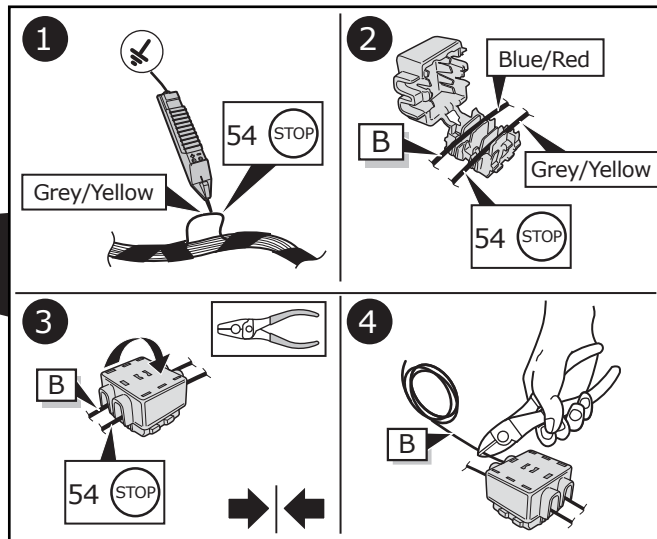
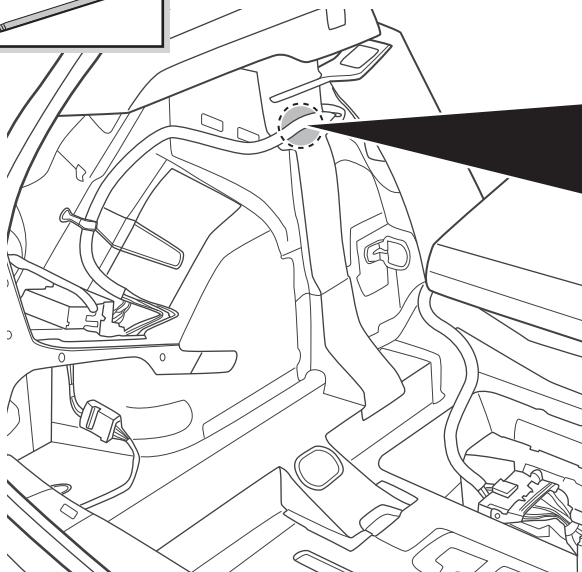
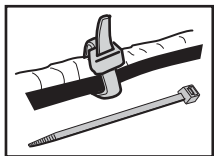

16

Option 2

>> 10/2019

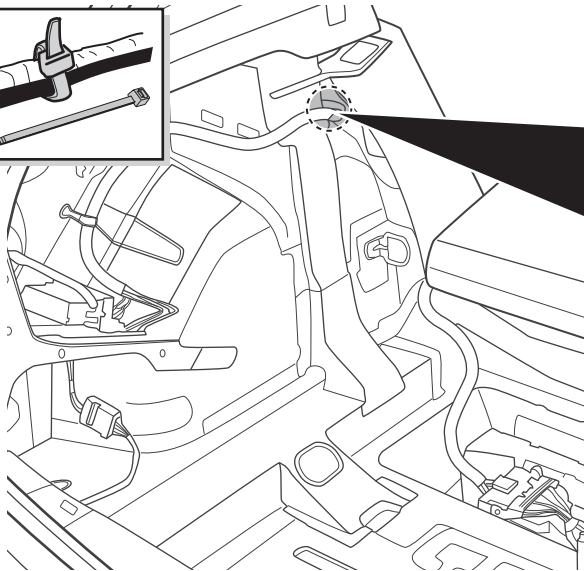
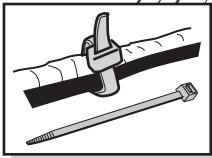

17

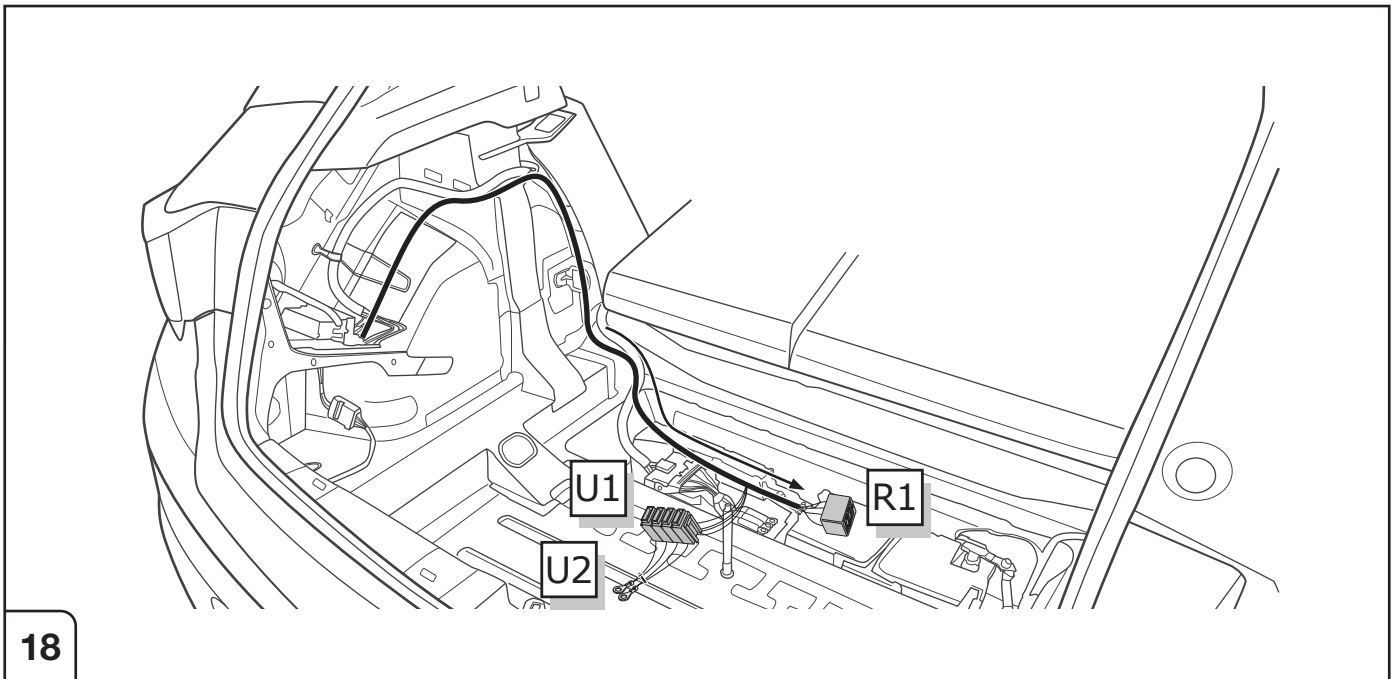
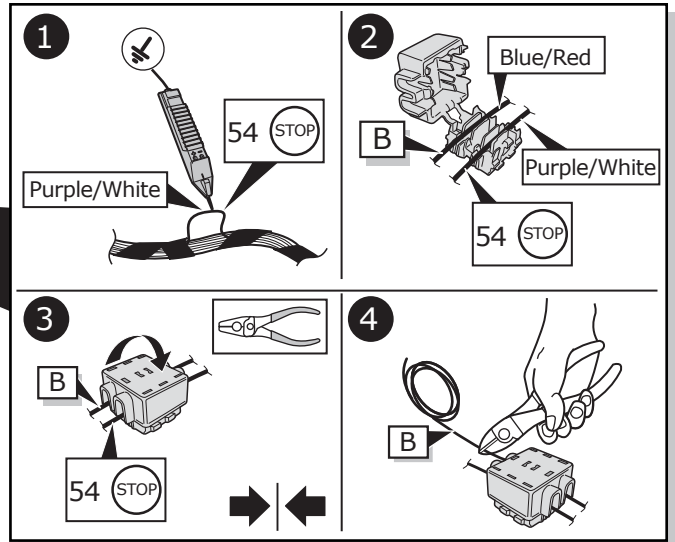

18

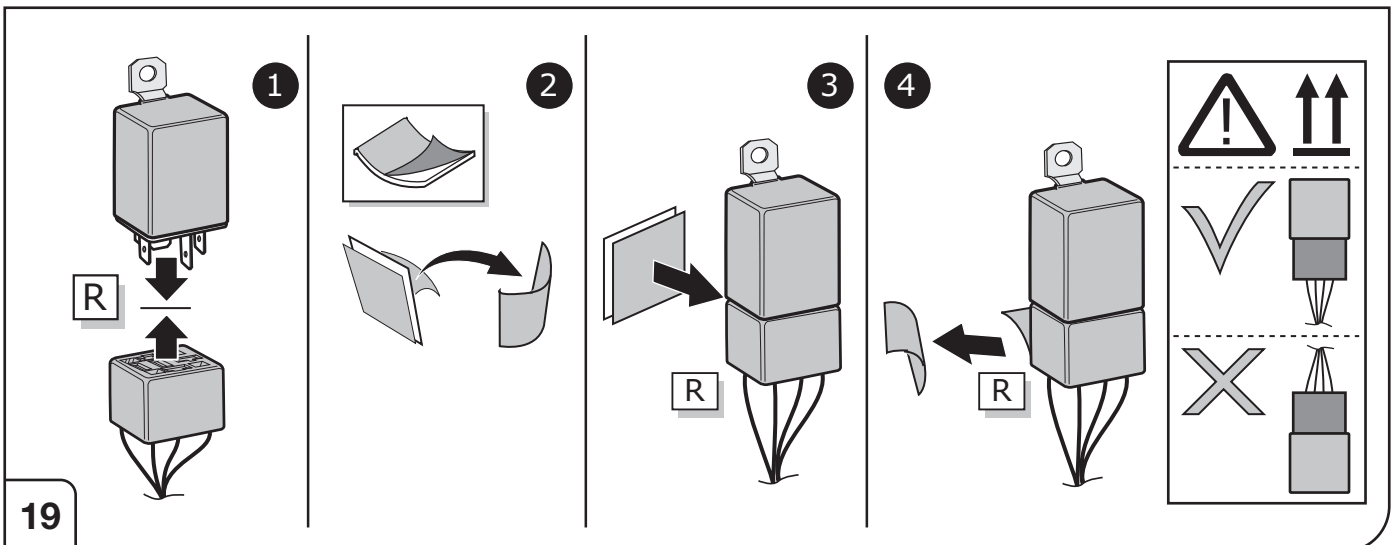

19

20

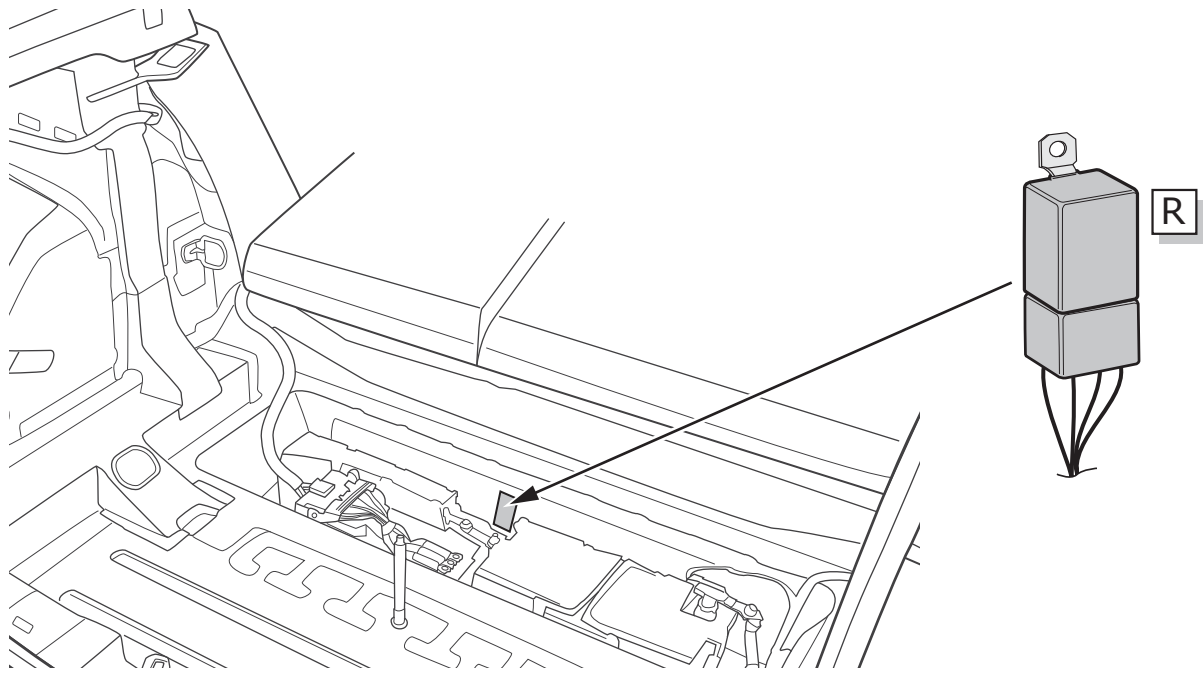

21

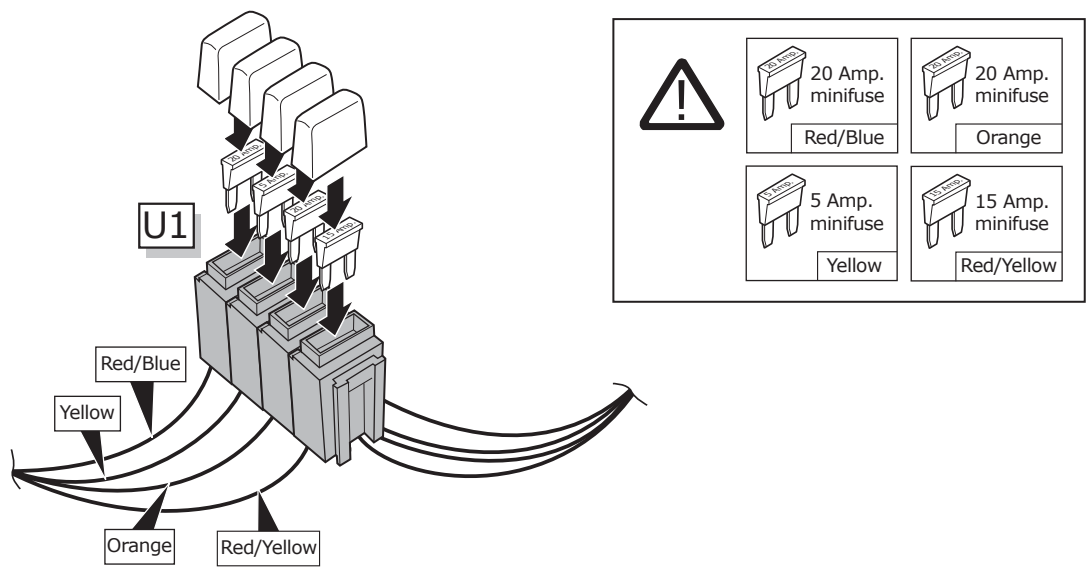

22

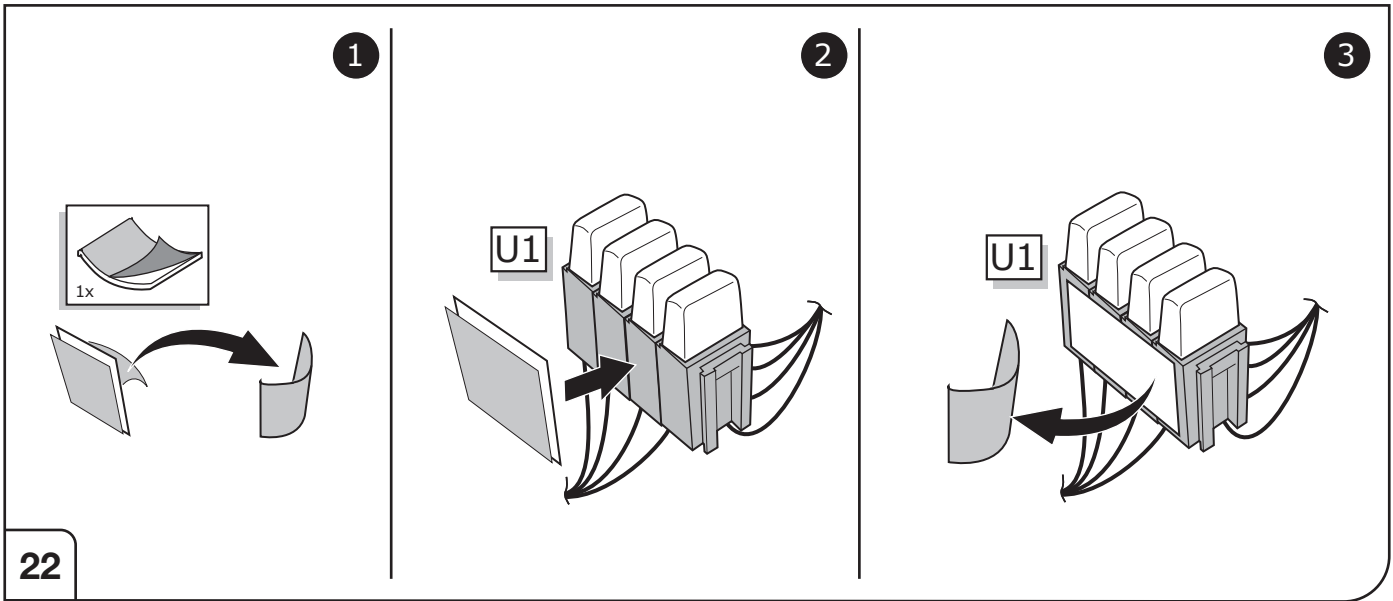

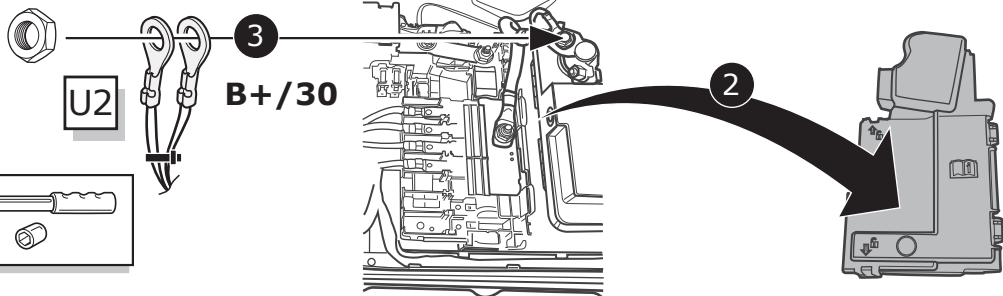
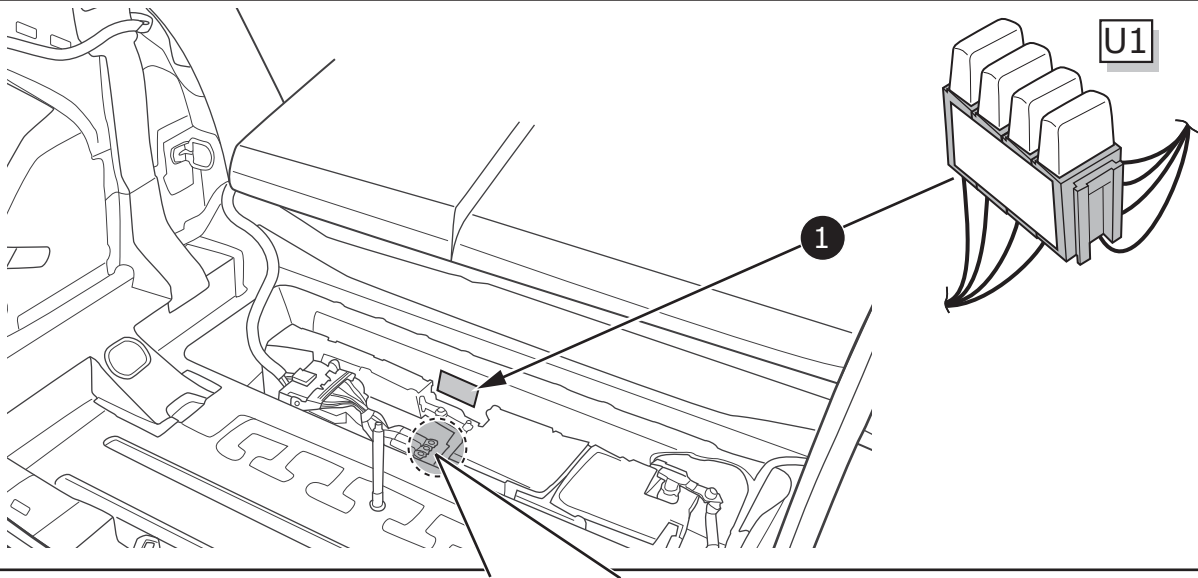

23

5HB

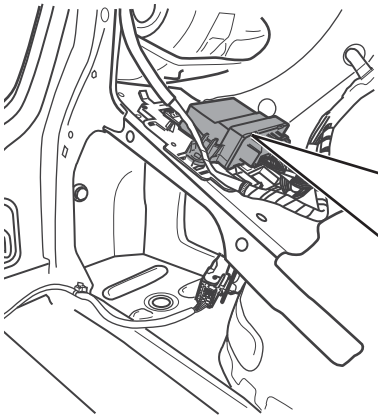

Option 1

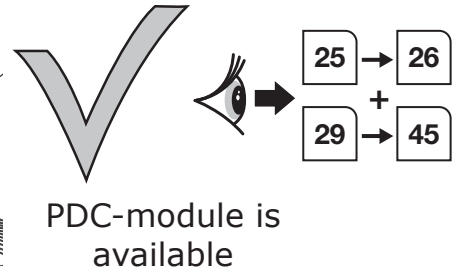
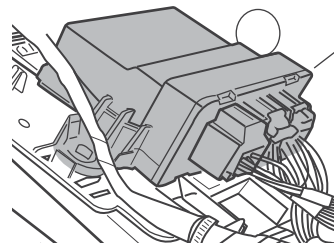

PDC-module is available

Sports Tourer

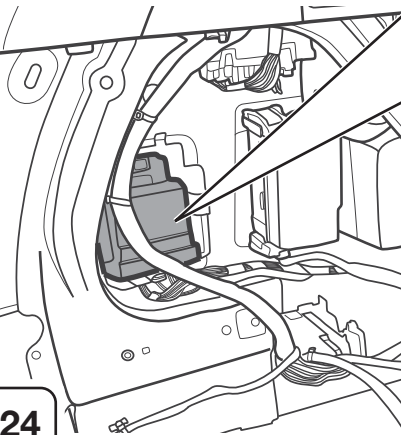

Option 2

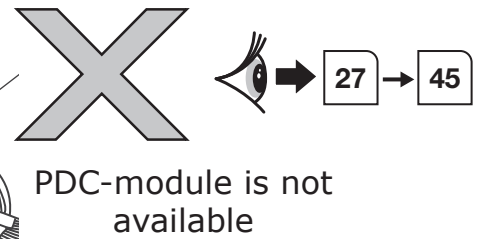
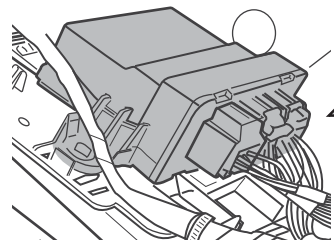

PDC-module is not available

24

Option 1

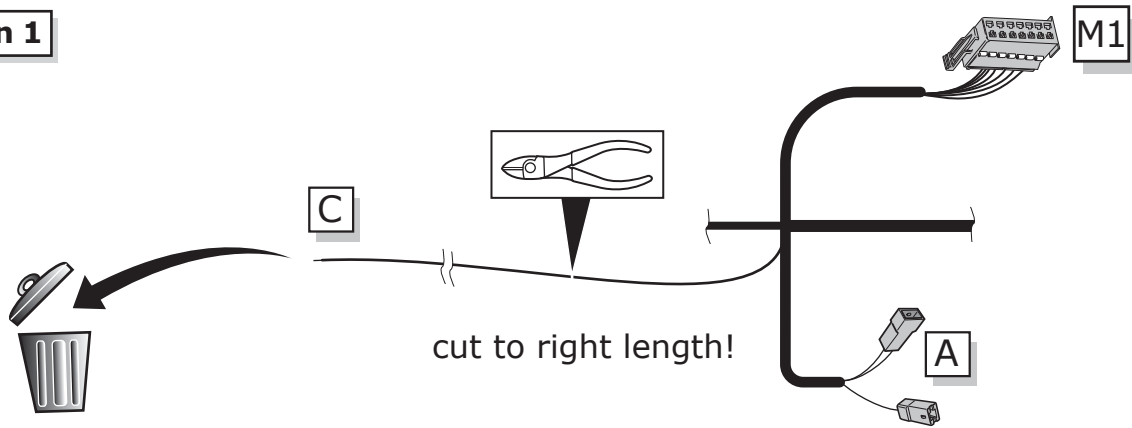

25

Option 1

! Important!
Please note informations
in picture 1!

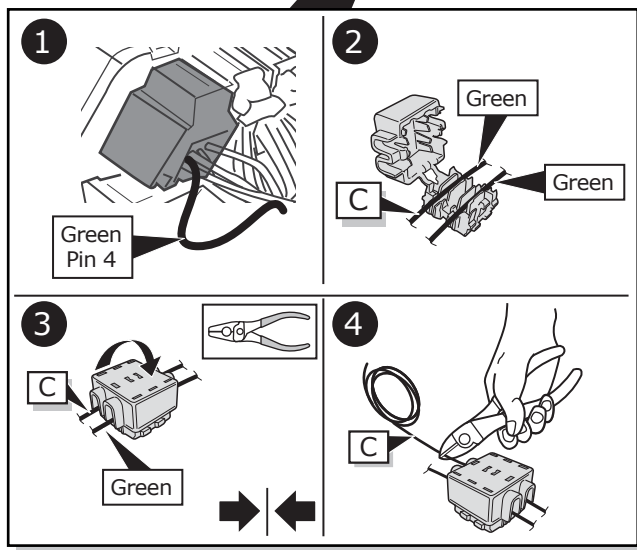
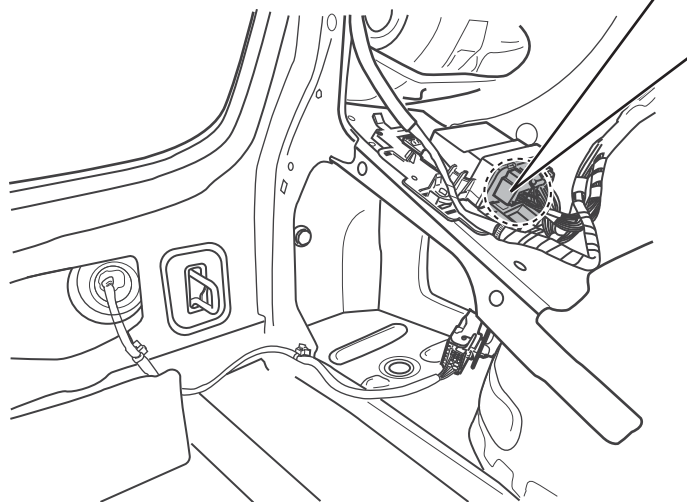
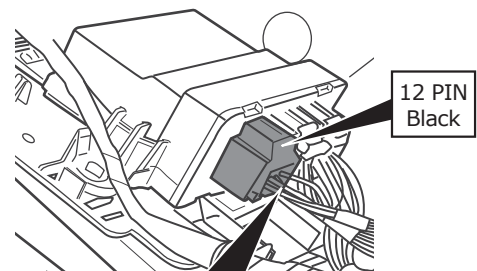

26

Option 2

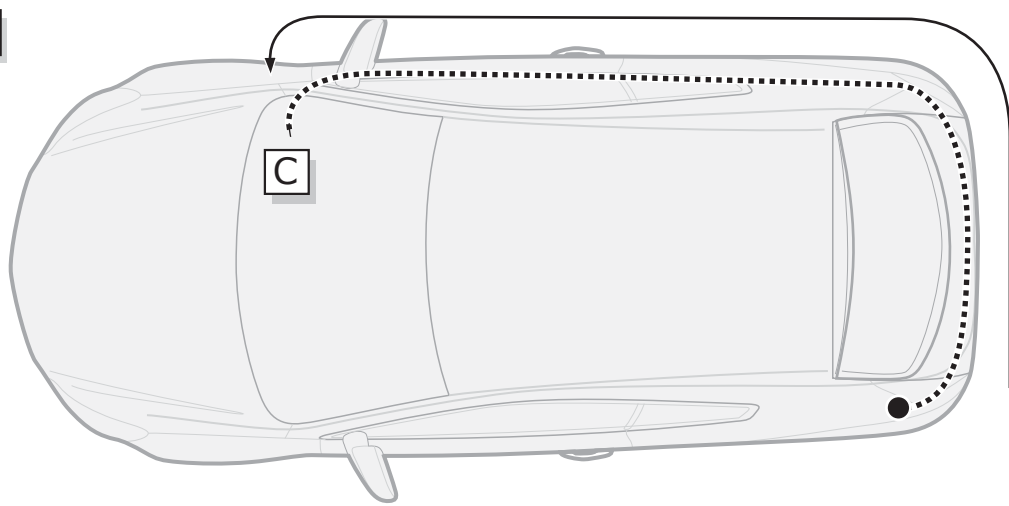

27

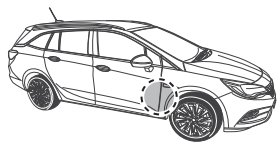

! Important!
Please note informations
in picture 1!

Option 2

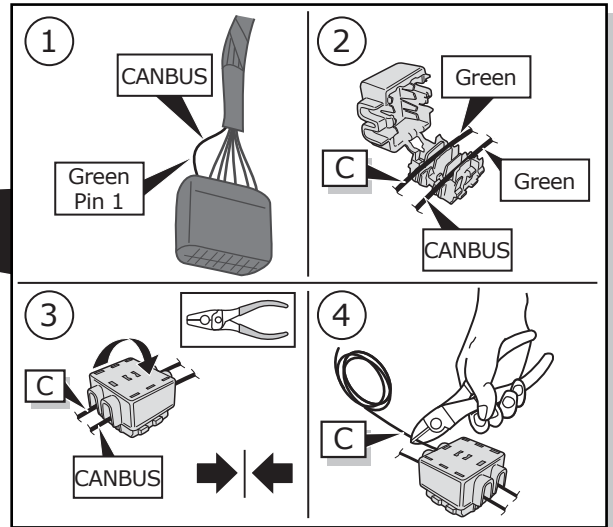
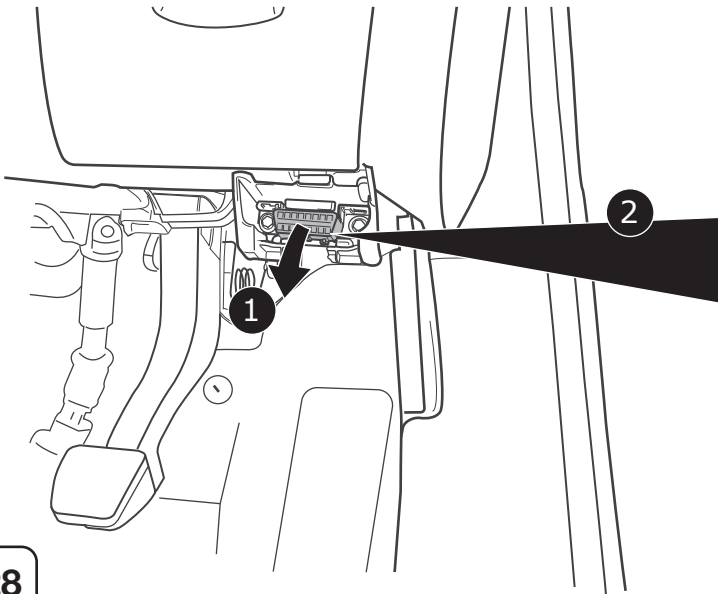

28

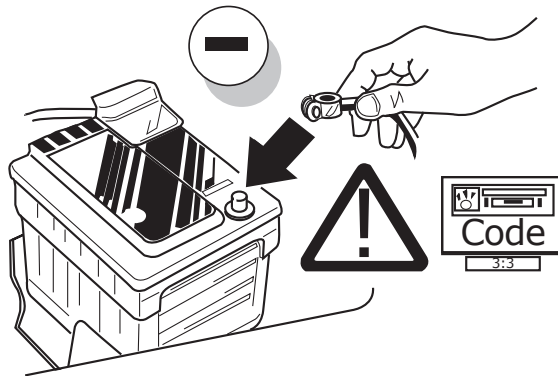

29

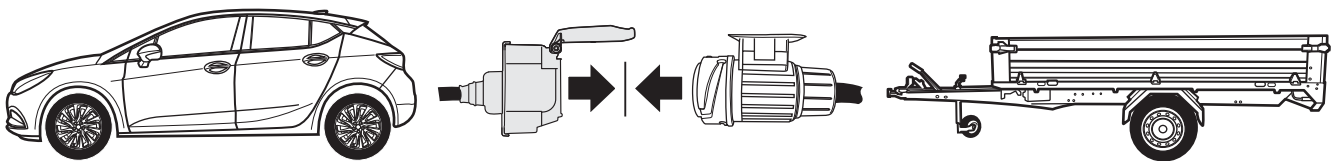

30

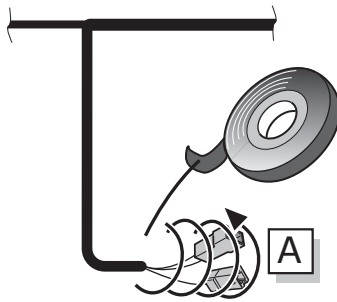
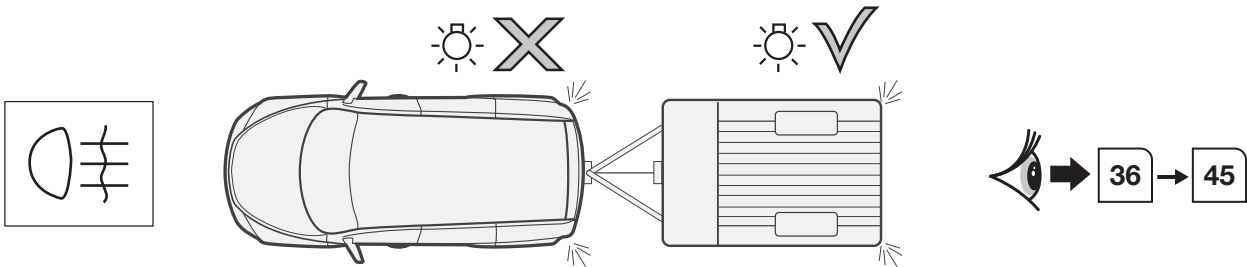
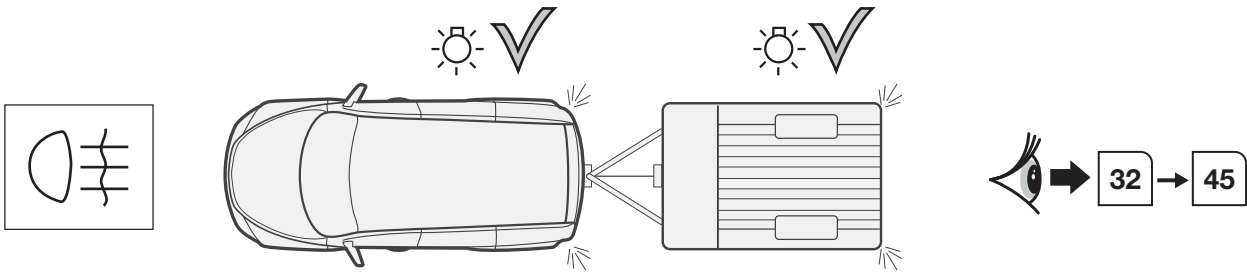

Not required!

31

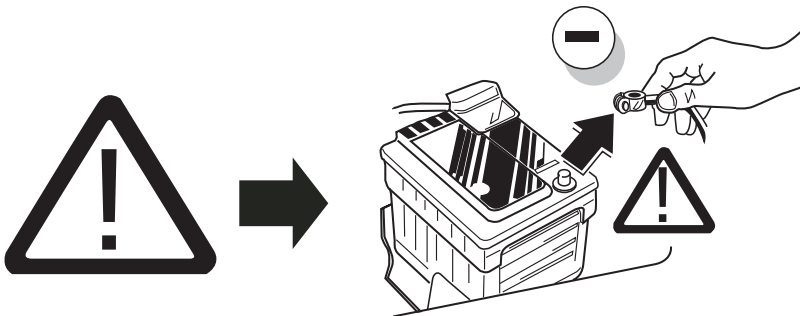

Note: It may be necessary to check if this vehicle has a stored radio code before disconnecting the battery!

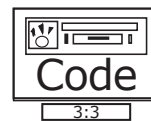

32

5-doors

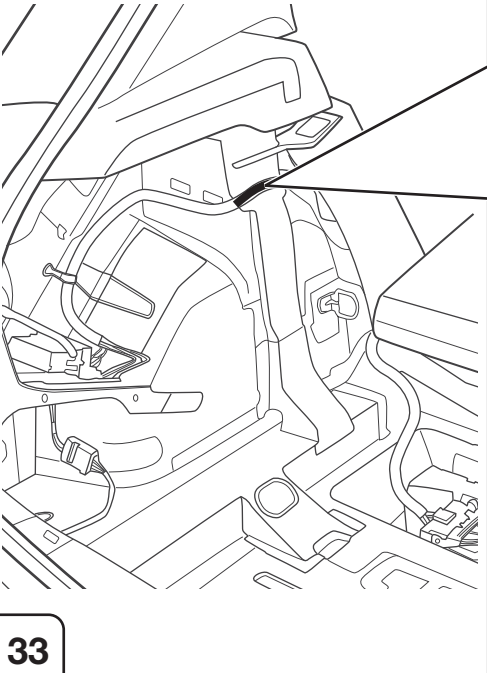
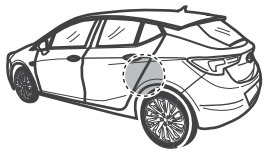

33

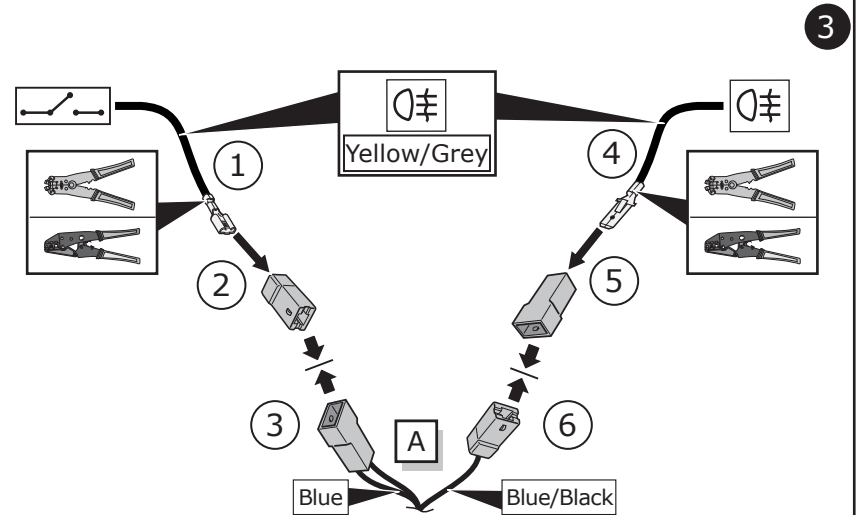
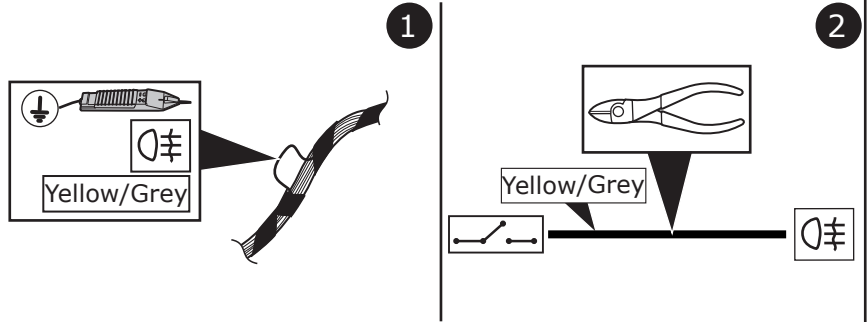

Sports Tourer

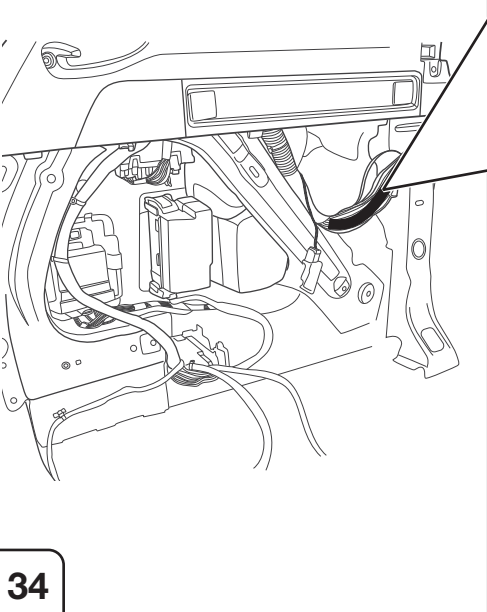
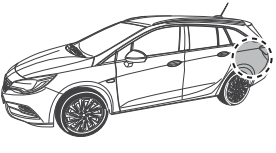

34

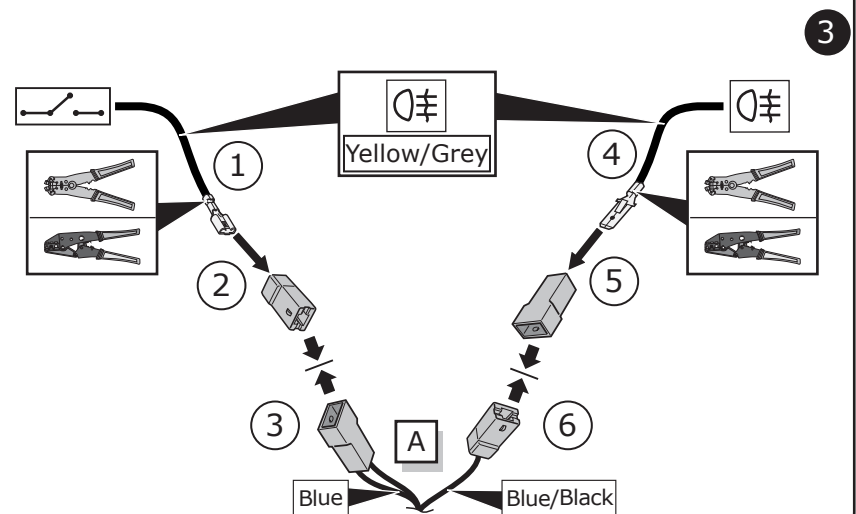
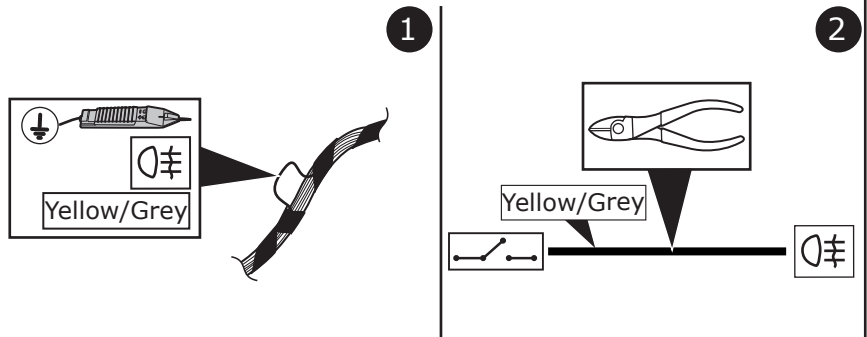

5-doors

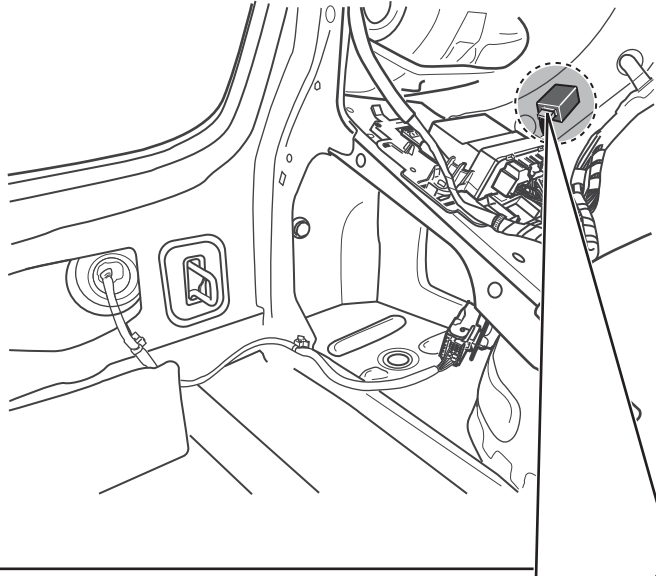

1

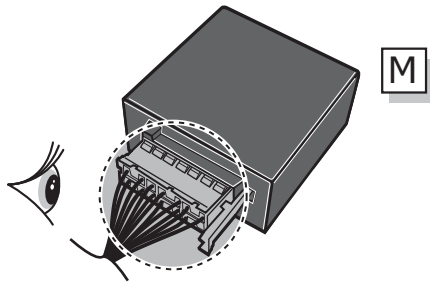

Sports Tourer

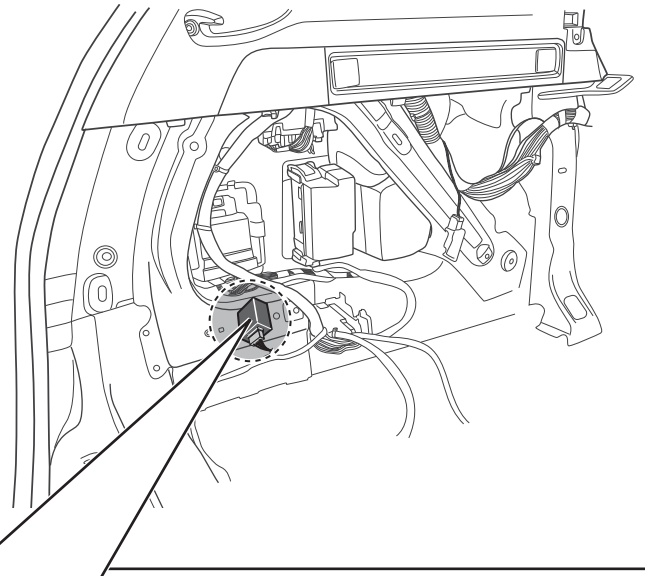

2

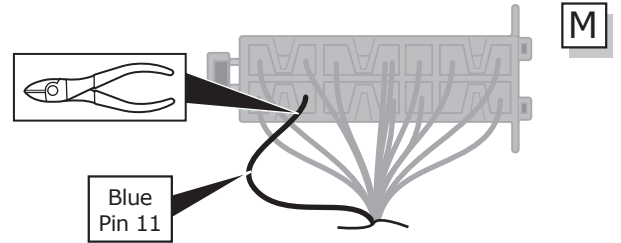

3

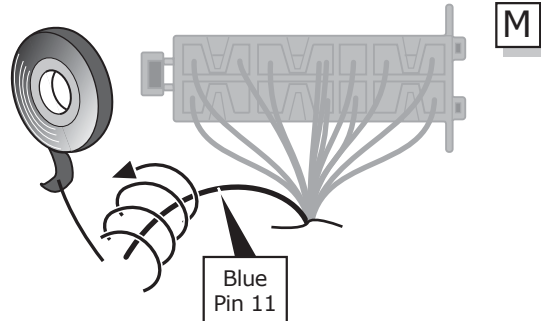

35

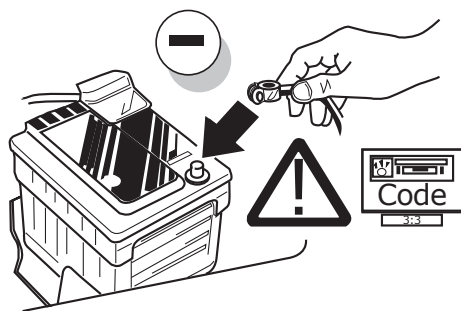

36

INFO

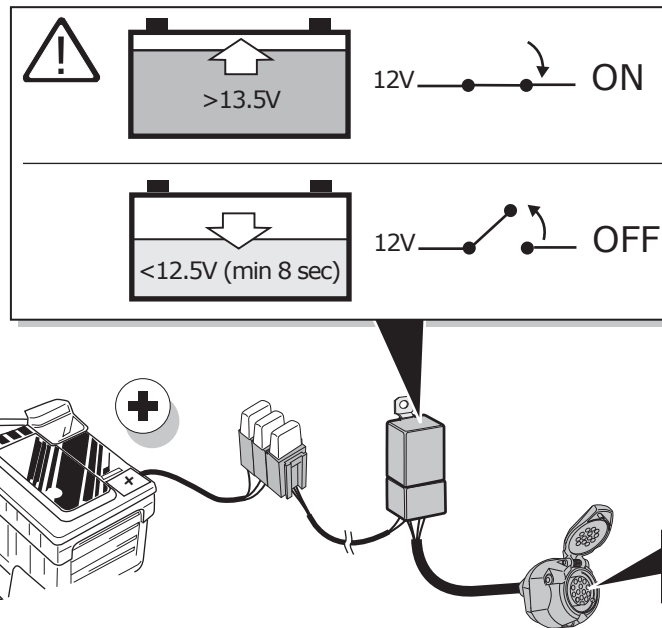

37

IMPORTANT!

The Voltage Control Module (VCM) in this kit is designed to be self switching at a pre-set voltage input. With the engine started, the switched output (e.g. caravan fridge or alternative), pin 10, will switch on at a preset figure of 13,5 volts.

When the engine is switched off, the switched output will remain live until the vehicle battery voltage drops to a preset figure of approx 12,5 volts.

NOTE: The cut-off voltage depends on the condition of the vehicle battery, power consumption of the fridge etc. In all cases, the cut-off figure is preset so the vehicle engine can be started at any time.

38

Optional

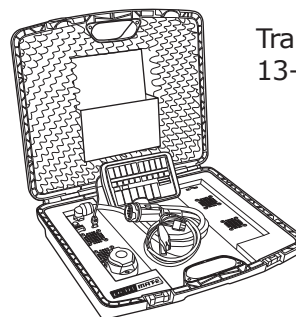

Trailer Simulator for 7- and 13-pin Sockets

39

Functional test

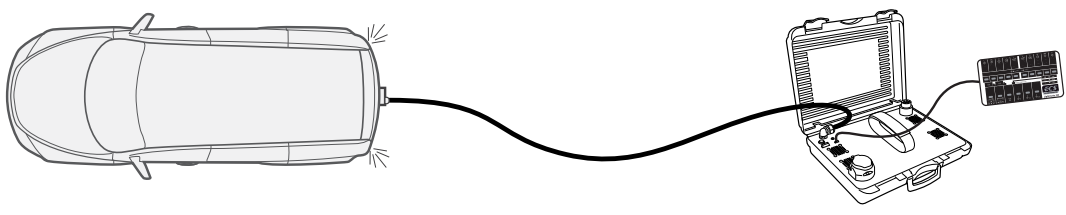
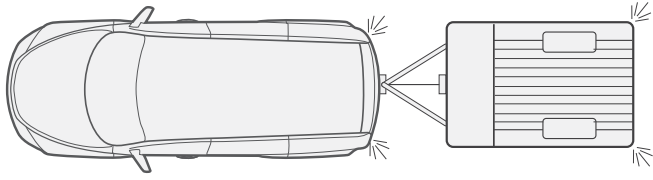
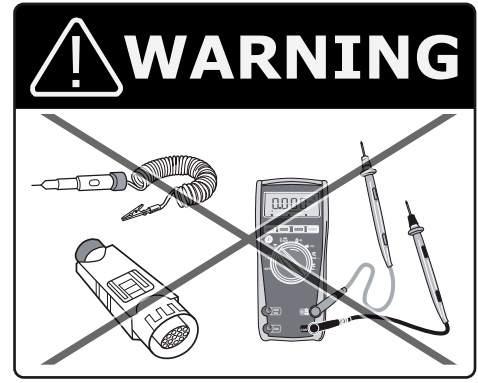
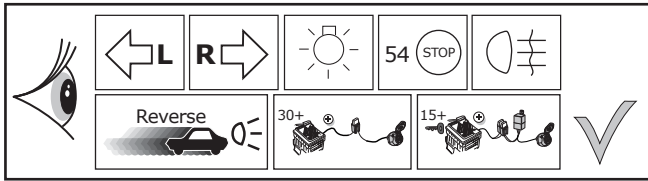

40

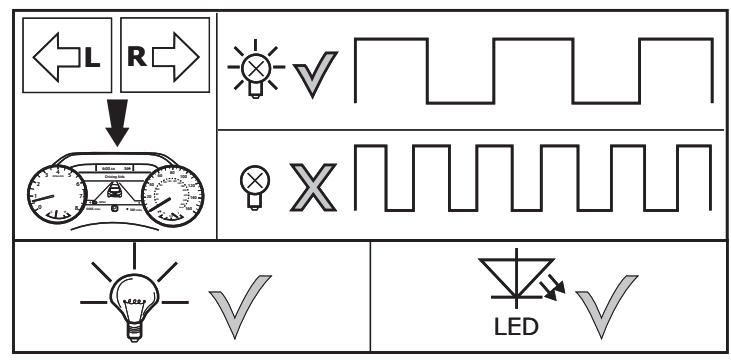
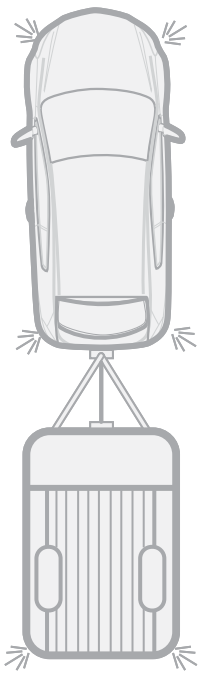

41



The following lamp functions for the trailer are not supported by all towing vehicles with DRL circuit:

- Rear lights
- Side lights
- Numberplate lights

The parking lights or dimmed headlights must be switched on to activate this function!

42

Optional

Adapter socket

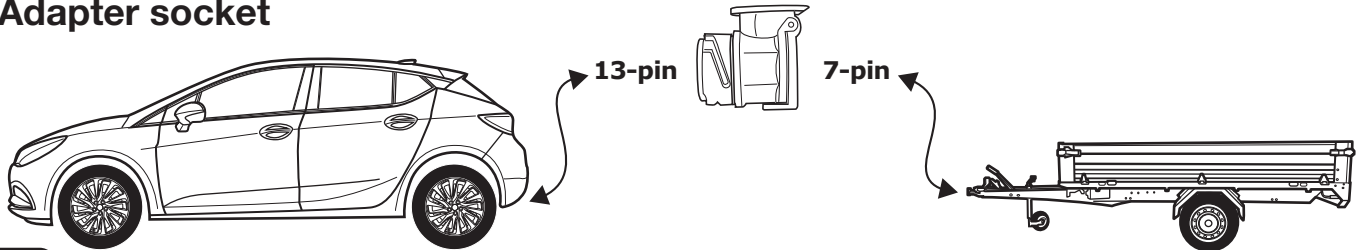

43

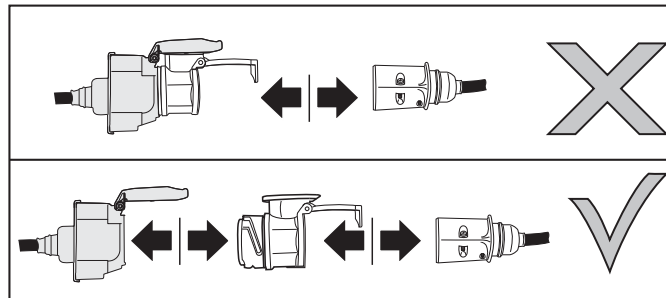
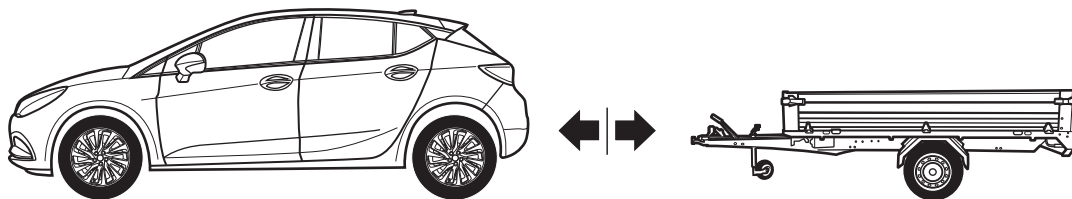

44

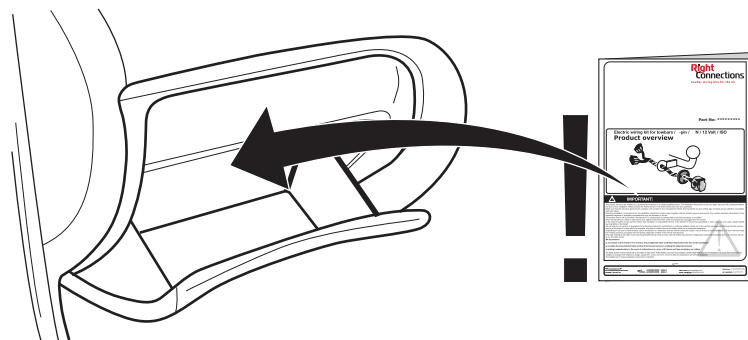

45

SOCKET CONNECTION

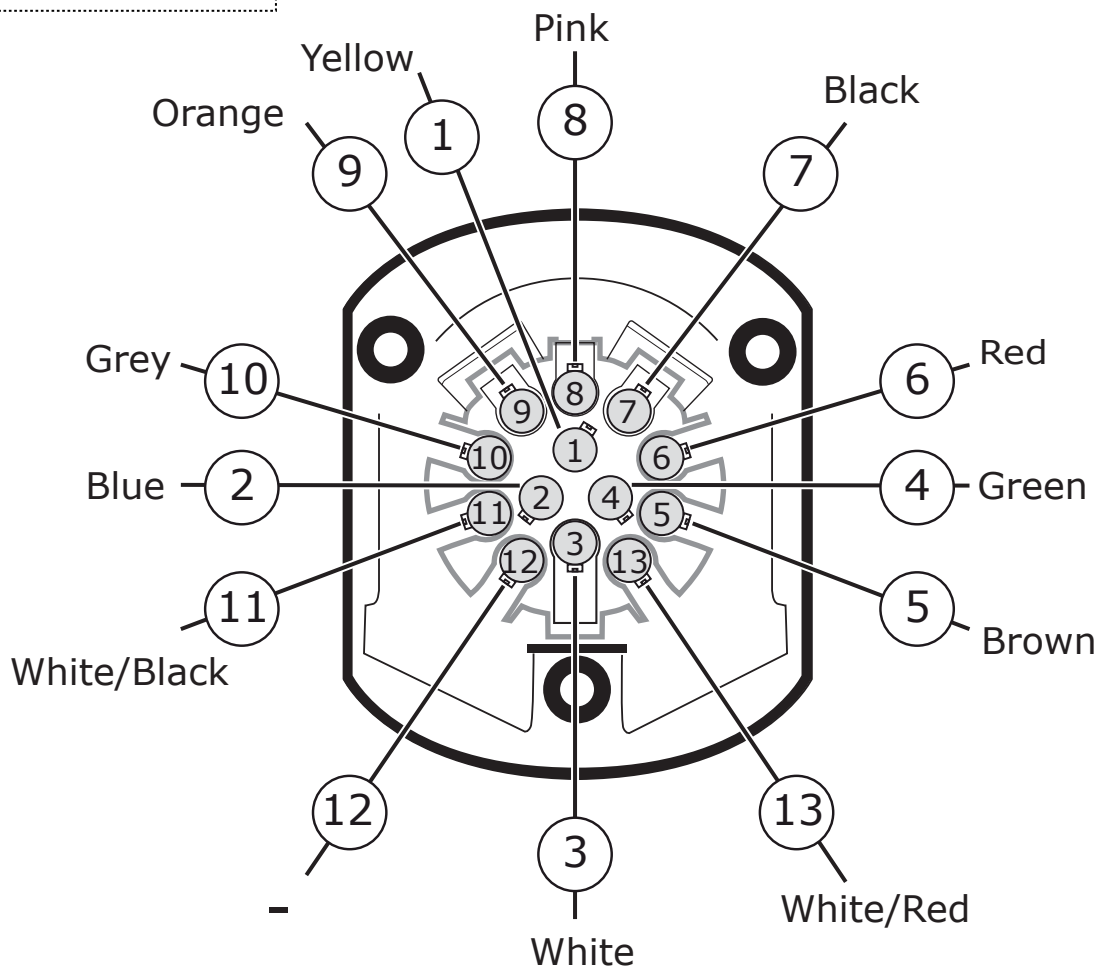
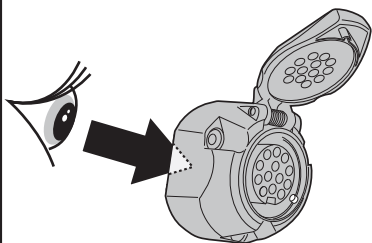

SOCKET CONNECTION

DIN/ISO 11446													
Pmax	21W	21W		21W	42W	3x21W	42W	21W	Option	Option			
Colour	Yellow	Blue	White	Green	Brown	Red	Black	Pink	Orange	Grey	White/Black	-	White/Red