

Right Connections

towbar wiring kits for the uk

Ford

Tourneo Connect III Grand 05/2022 >>
Tourneo Connect III Transit 05/2022 >>
Connect III 05/2022 >>

Volkswagen

CADDY V 11/2020 >>
CADDY V Maxi 11/2020 >>
CADDY V Cargo 11/2020 >>
CADDY V Kombi 11/2020 >>
CADDY V California 11/2020 >>
CADDY V PanAmericana 11/2020 >>
T7 Multivan 11/2021 >>

Part No: VW-281-13M

Electric wiring kit for towbars / 13-pin / 12 Volt / ISO 11446 Fitting instructions

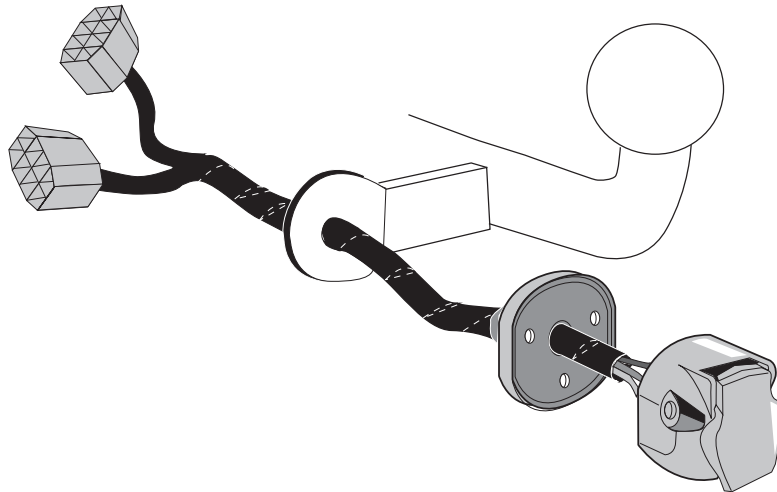

IMPORTANT!

This electric kit has to be installed by a professional workshop or a suitable qualified person.

The installation instructions must have been read and fully understood before the start of any installation. Please contact your wiring kit provider or the hotline shown in the footer should you need assistance!

Make sure the vehicle is approved/homologated by the manufacturer to tow a trailer!

Also please check that there is a definite compatibility between this vehicle and the electric kit!

Following the installation of the electric kit, the fitting instructions should be kept together with the vehicle service document and vehicle handbook. The fitting instructions contain important information relating to the use and function of the towing kit as well as for any diagnostic or activation process, that might have to be repeated in the future (e.g. after the performance of a vehicle software update).

All warranty claims will be forfeited if the electric kit or components contained therein are used incorrectly or modified. If a towing socket adaptor has been used to connect to the trailer or bike rack, this must be removed from the trailer socket once the trailer or bike rack has been disconnected.

If the trailer or bike rack is not equipped with a rear fog lamp, depending on the towing vehicle type, the correct function of the towing kit cannot be guaranteed. In such cases, a rear fog lamp should be retro fitted.

This towing electric kit will not be covered under warranty if any technical or electrical modifications or software updates have been performed by the vehicle manufacturer after the initial commissioning of the kit. That applies especially to modifications or updates which may cause malfunctions in the trailer socket or any other part of the trailer electrical equipment!

Depending on the type of trailer module used in this electric kit, diagnostic interrogation with the vehicle's electrical system may be limited or will not function. The error memory inside the trailer module may not be able to be accessed by vehicle manufacturers diagnostic system.

Error logs relating to the trailer electrical equipment, that may be generated in the vehicle manufacturers diagnostic system as a result of a test procedure, may be due to the incorrect installation of the towing electric kit or the false activation of the trailer module.

We always recommend whenever possible, the following troubleshooting process:

→ An analysis of the vehicle's error memory and possibly clearing of all faults before the start of the installation!

→ Try disconnecting the trailer module from the towing harness and re-start the fault clearing process!

→ If in doubt, limit the time for troubleshooting to a max of 0,5 hours and call our Technical Support Team!

Please follow our instructions carefully and always test the towing electrics using a true lighting board or a specifically designed bulb tester. If an LED tester is used, ensure it is equipped with correct load resistors or malfunctions will occur!

This instruction is subject to changes and we reserve the right to make changes to design, colour etc.

All of the data and illustrations may not be an exact representation but the text contained in this instruction must be observed!

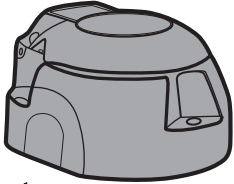
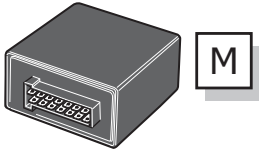

U1

U4

M

30x

L2

L3

L1

G

L5

L4

T

X

L6

L7

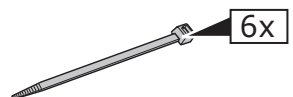
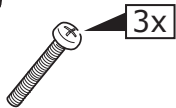

U3

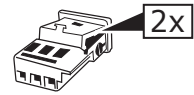
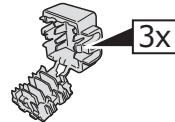
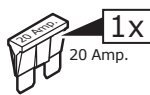

VW T7 Multivan

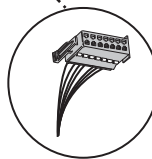
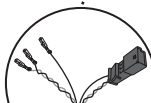
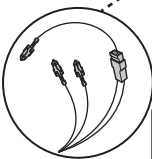
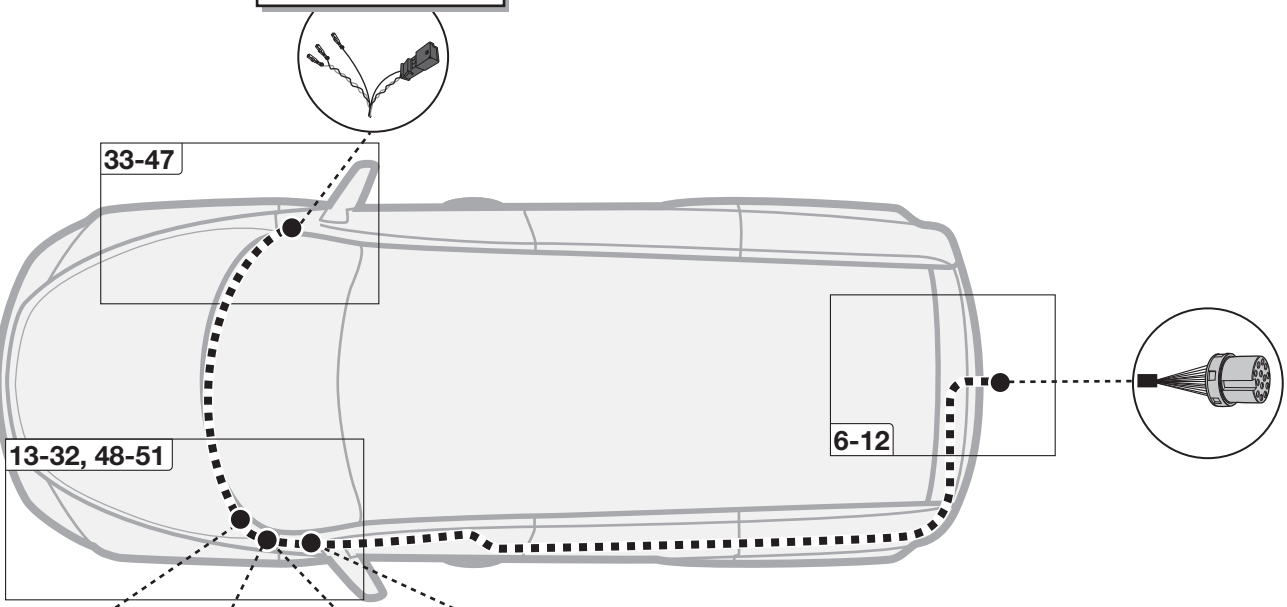

FORD TOURNEO & VW CADDY

SYMBOL EXPLANATION

	Left (58-L) respectively Right (58-R) tail light
54	Stop light (54) / high mounted, third stop light (54)
	Turn signal indicator left
	Turn signal indicator right
	Rear fog light(s)
	Reversing light(s)
	Permanent power supply / 13pin socket, chamber 9
	Charging wire for trailer battery / 13pin socket, chamber 10
	Trailer / trailer recognition
B+ / 30	Permanent current power supply
	Ground or Earth (31)
	Ground connection battery terminal lug
	Positive connection battery terminal lug

	Cigarette lighter / accessory socket
	Loudspeaker / buzzer
	Park Distance Control
	Switch / source of function
	Connect together
	Disconnect
	Look at / See further information
	Look carefully at selected area
	Present / Occupied / OK
	Not present / Not occupied / Not OK
	Acoustic indication
	Attention / important advice
	Fuse / fuse capacity 20 Ampère

TOOLS

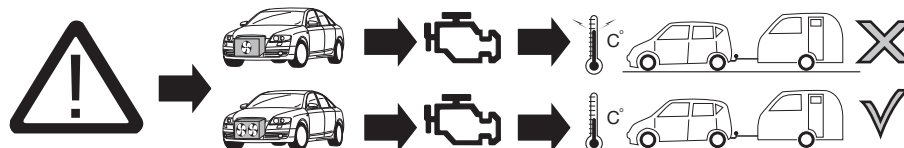
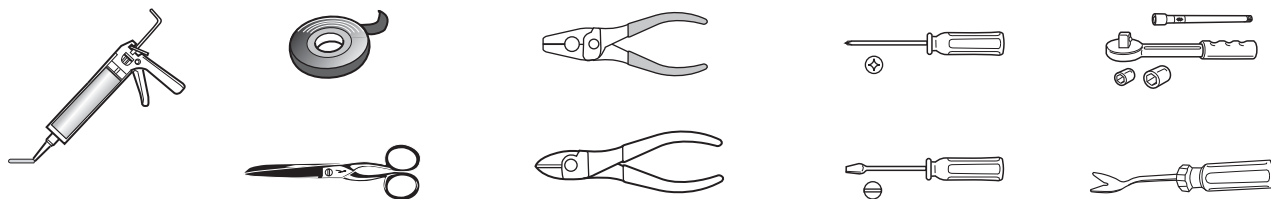

ATTENTION!

The vehicle's cooling capacity may have to be increased when retrofitting a trailer coupling!
You must observe the manufacturer's instructions!!



Note: It may be necessary to check if this vehicle has a stored radio code before disconnecting the battery!



ATTENTION!

In order to avoid mal-functions and damage to the vehicle's electrical system the earth terminal **must be disconnected** from the vehicle's battery **before starting work!**

Both the trailer module and the vehicle's control unit for the electrical system can be damaged during work on the data bus connections if the battery is not disconnected!

1

Please pay attention to the manufacturer's instructions when disconnecting and reconnecting the vehicle's battery!



FORD TOURNEO
& VW CADDY

VW T7 Multivan

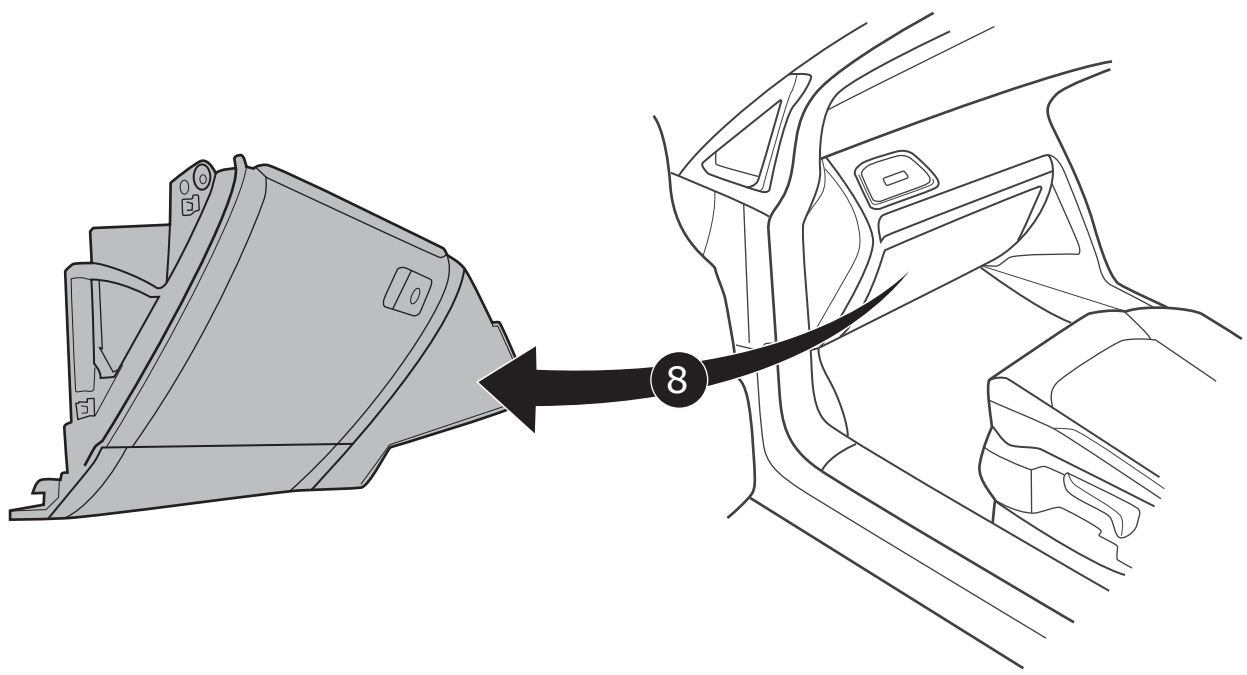
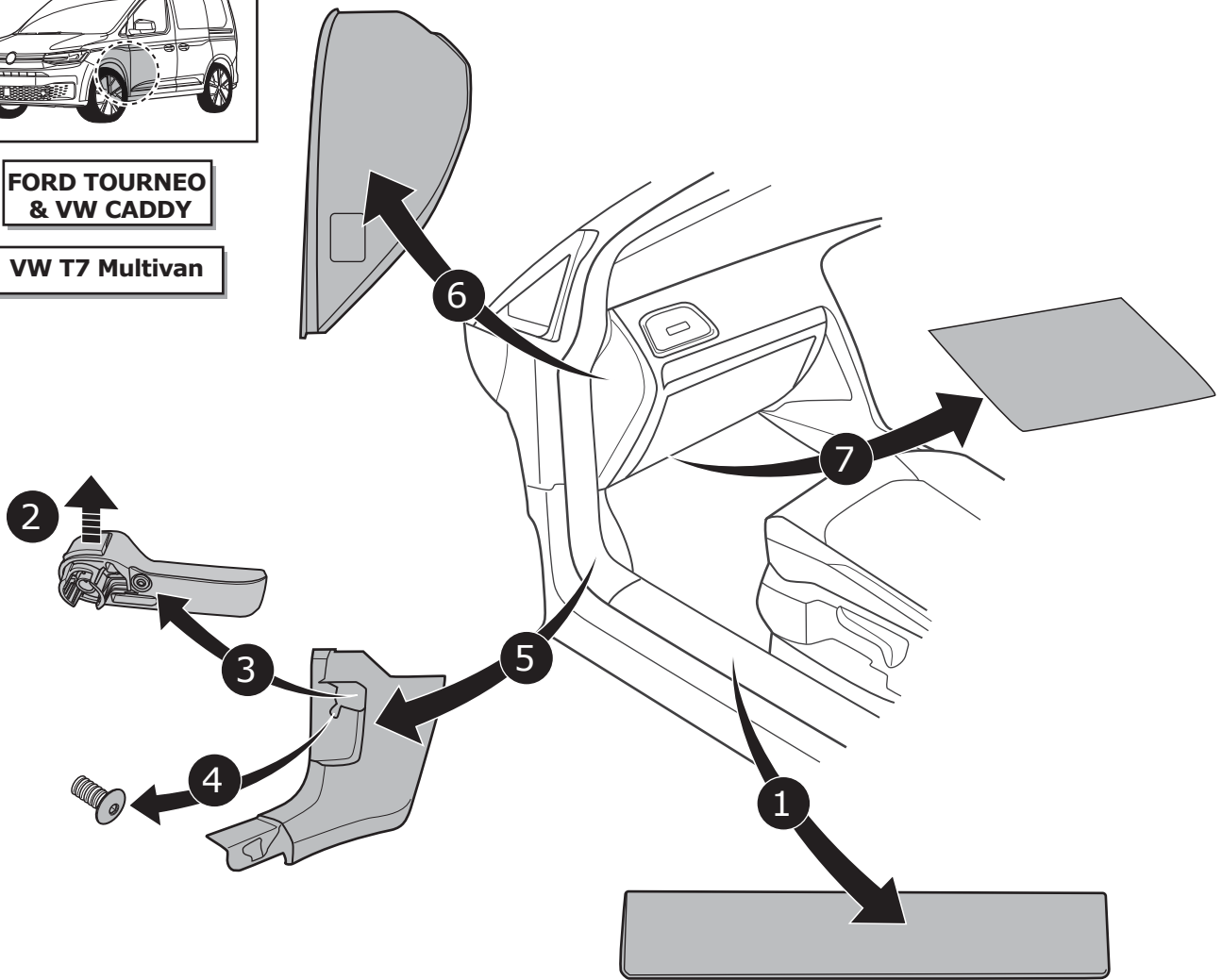

2

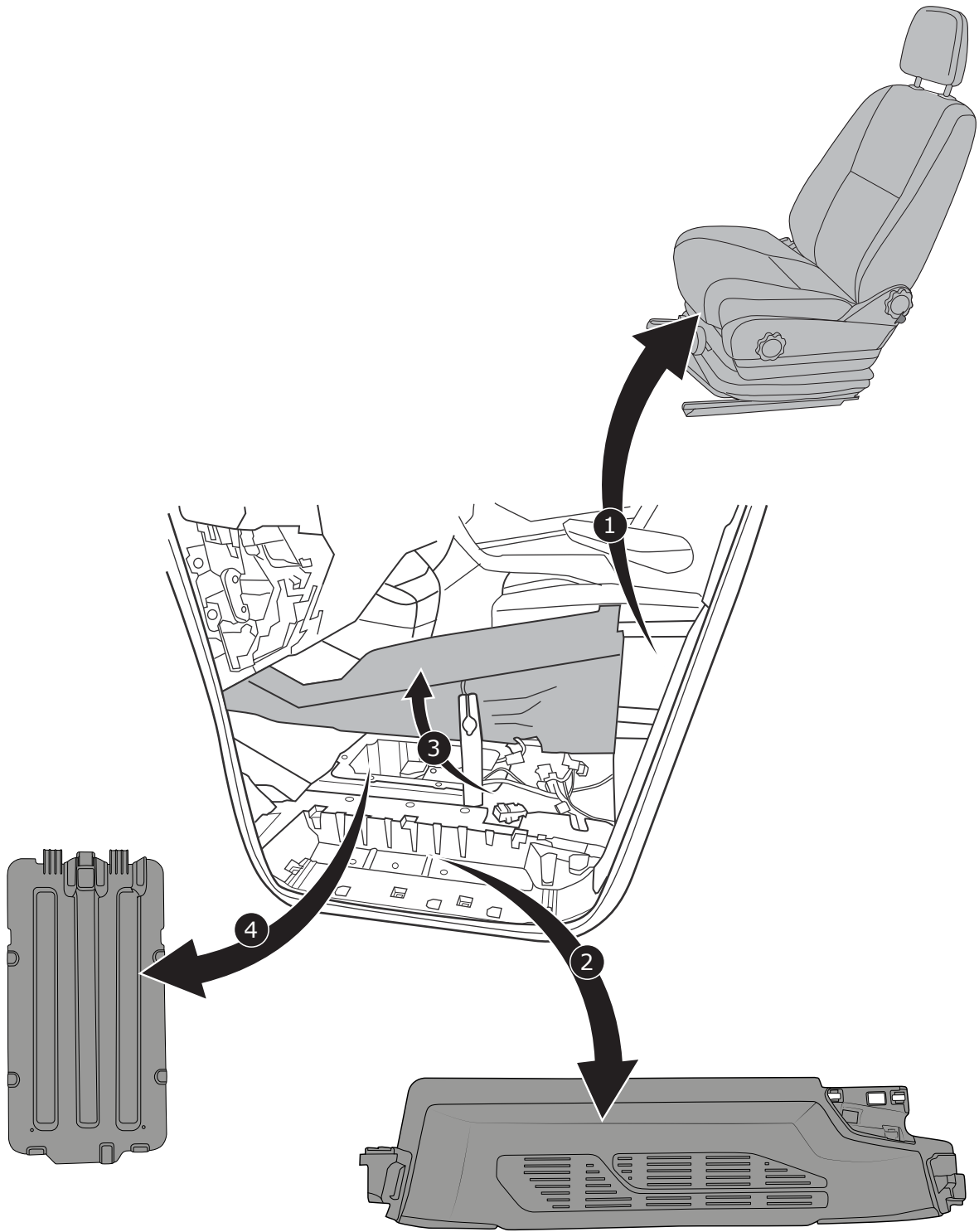



**FORD TOURNEO
& VW CADDY**

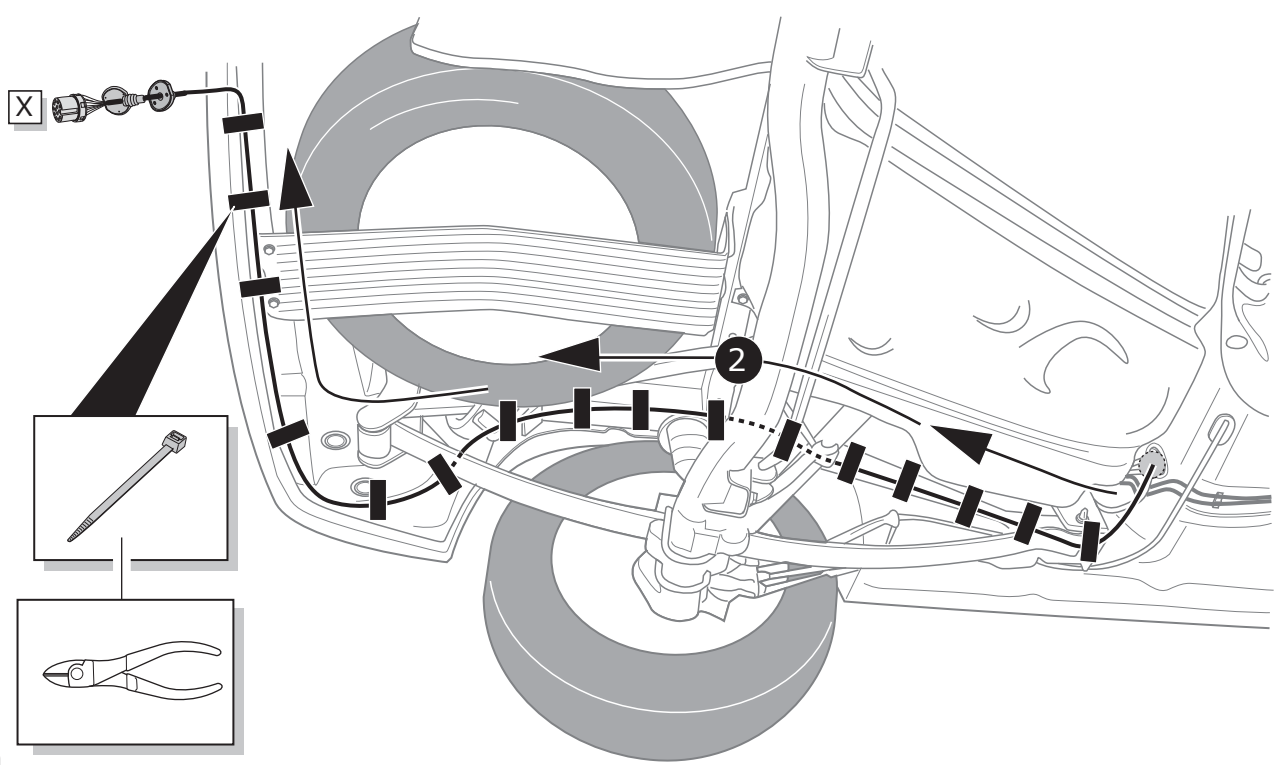
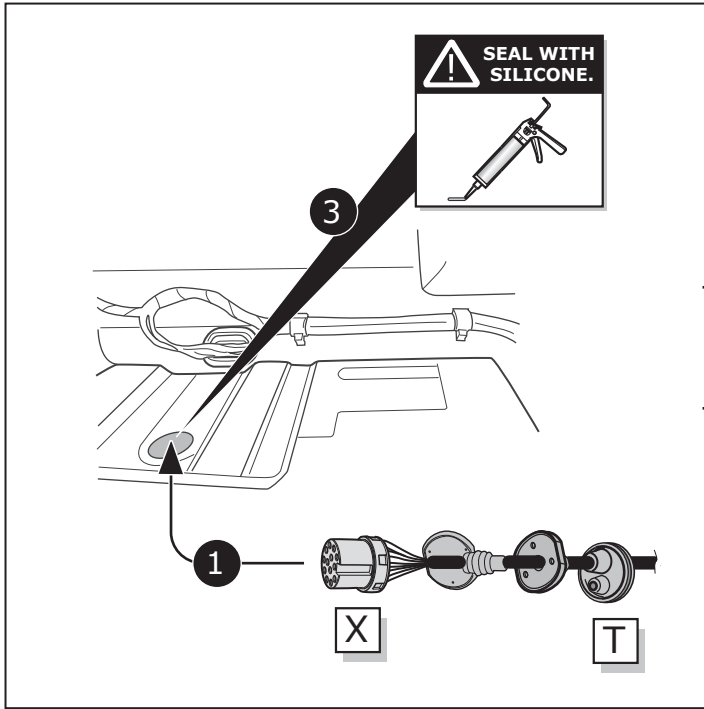
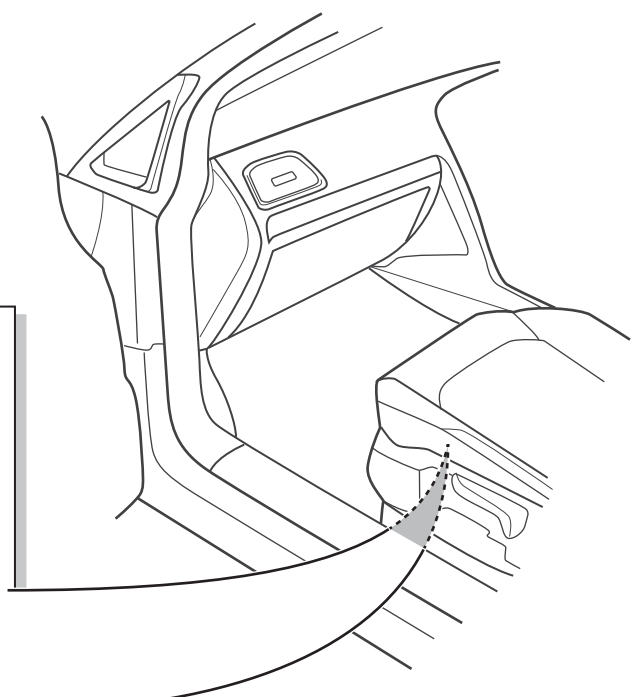



VW T7 Multivan

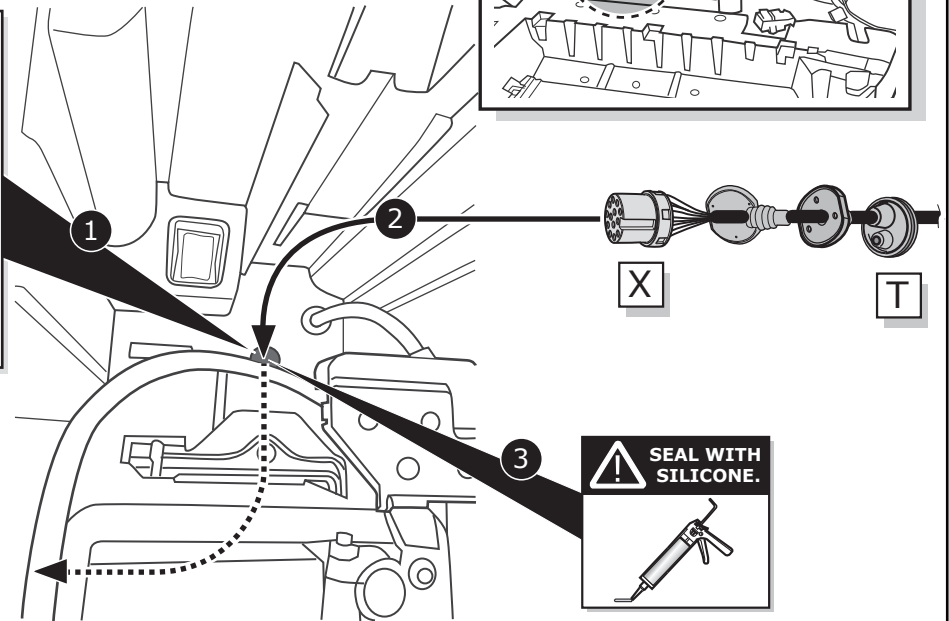
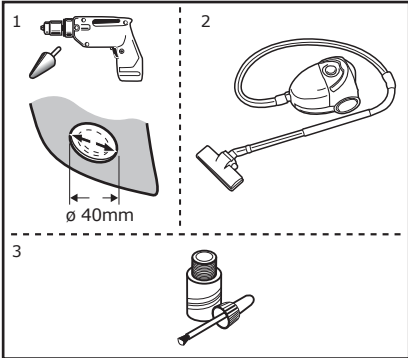
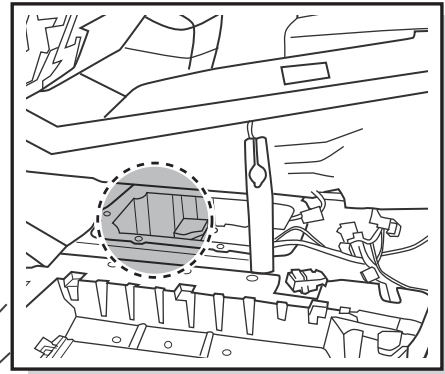

5

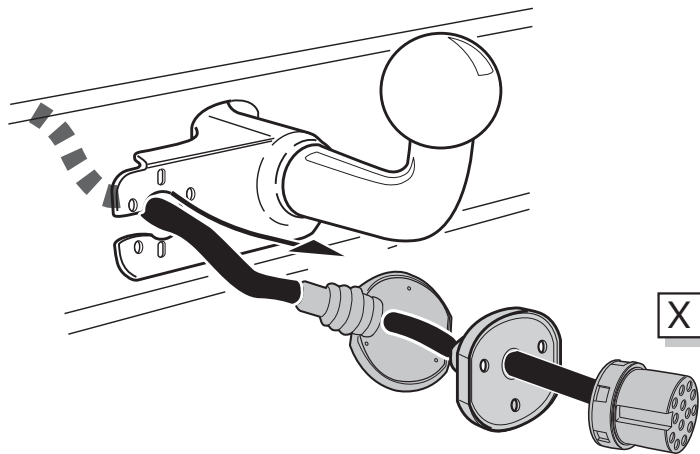

6

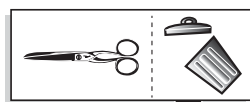

Option 1

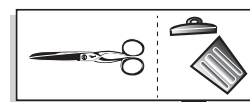
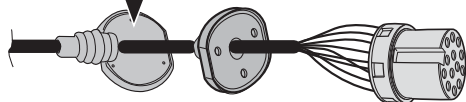

Option 2

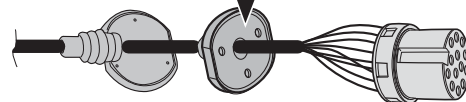

7



8

9

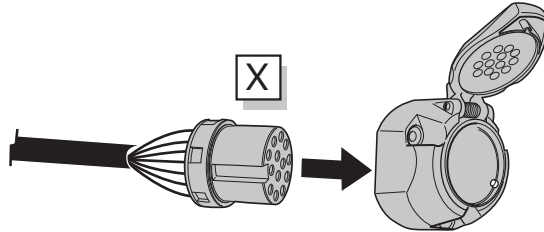

Option 1

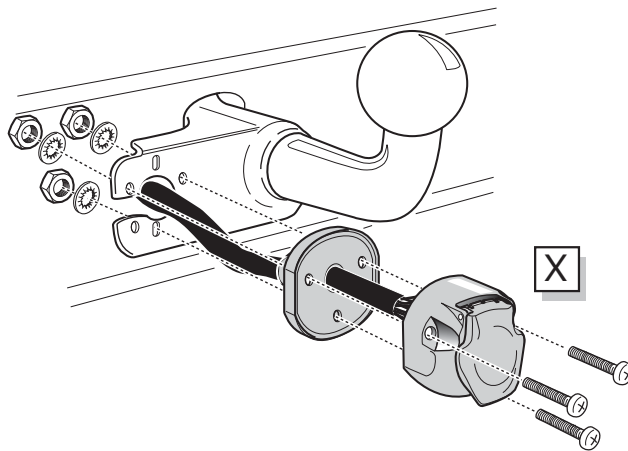

10

Option 2

1

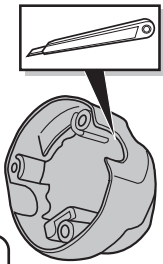

11

2

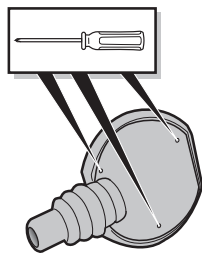

3

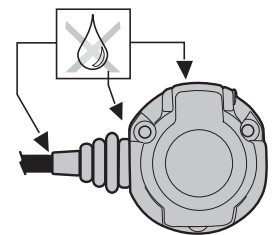
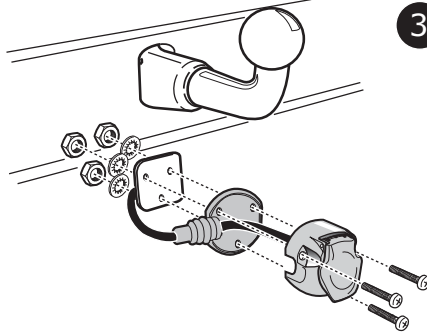

Option 2

1



12

2

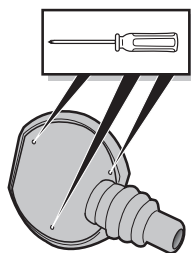

3

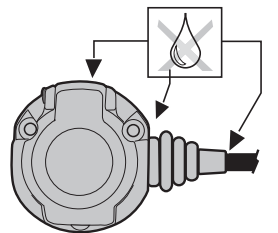
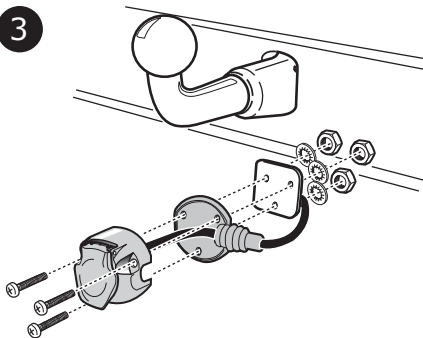

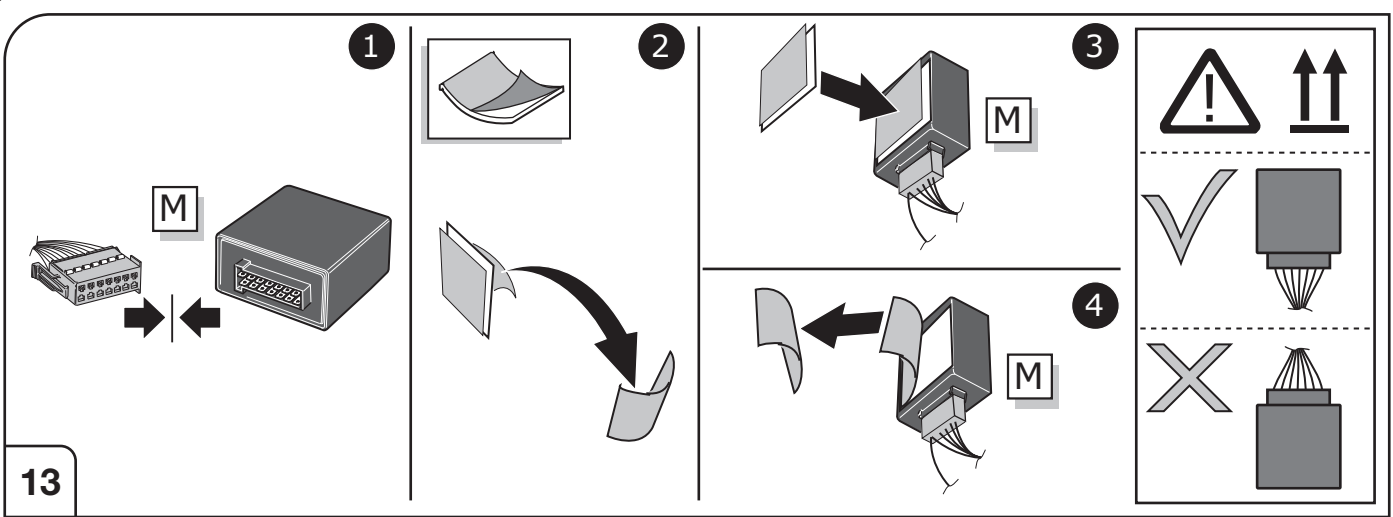

13

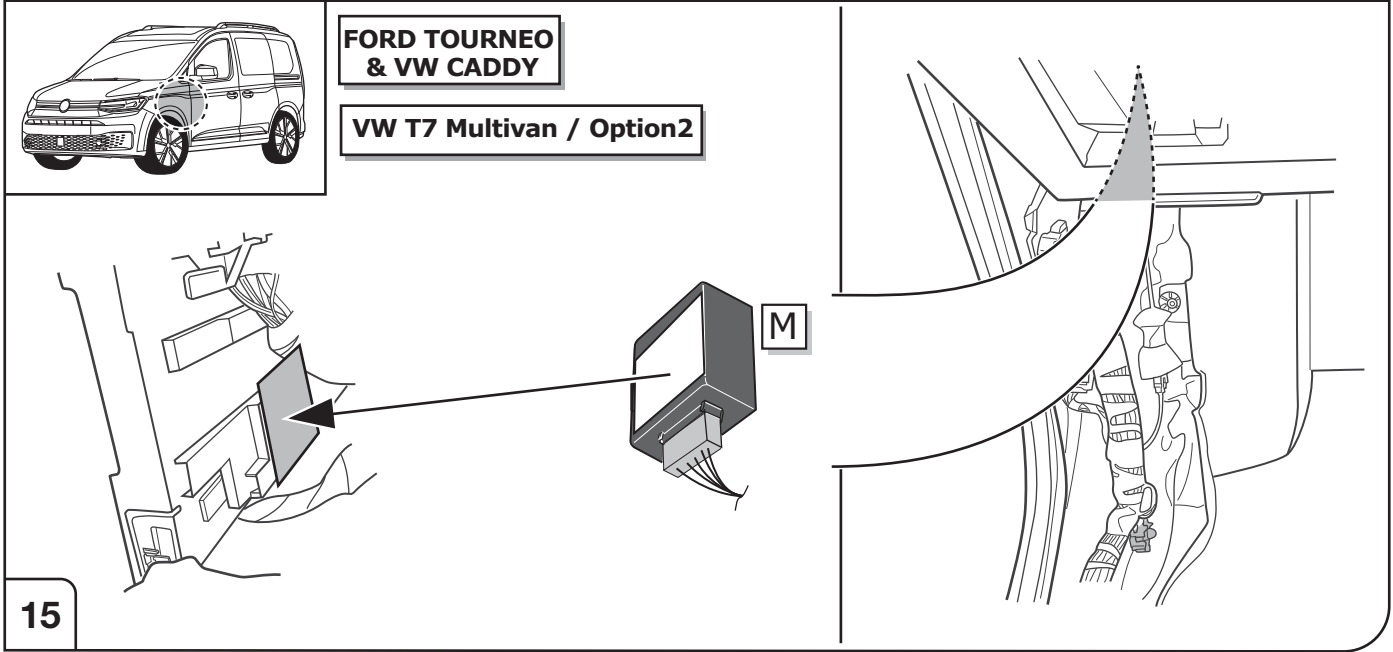
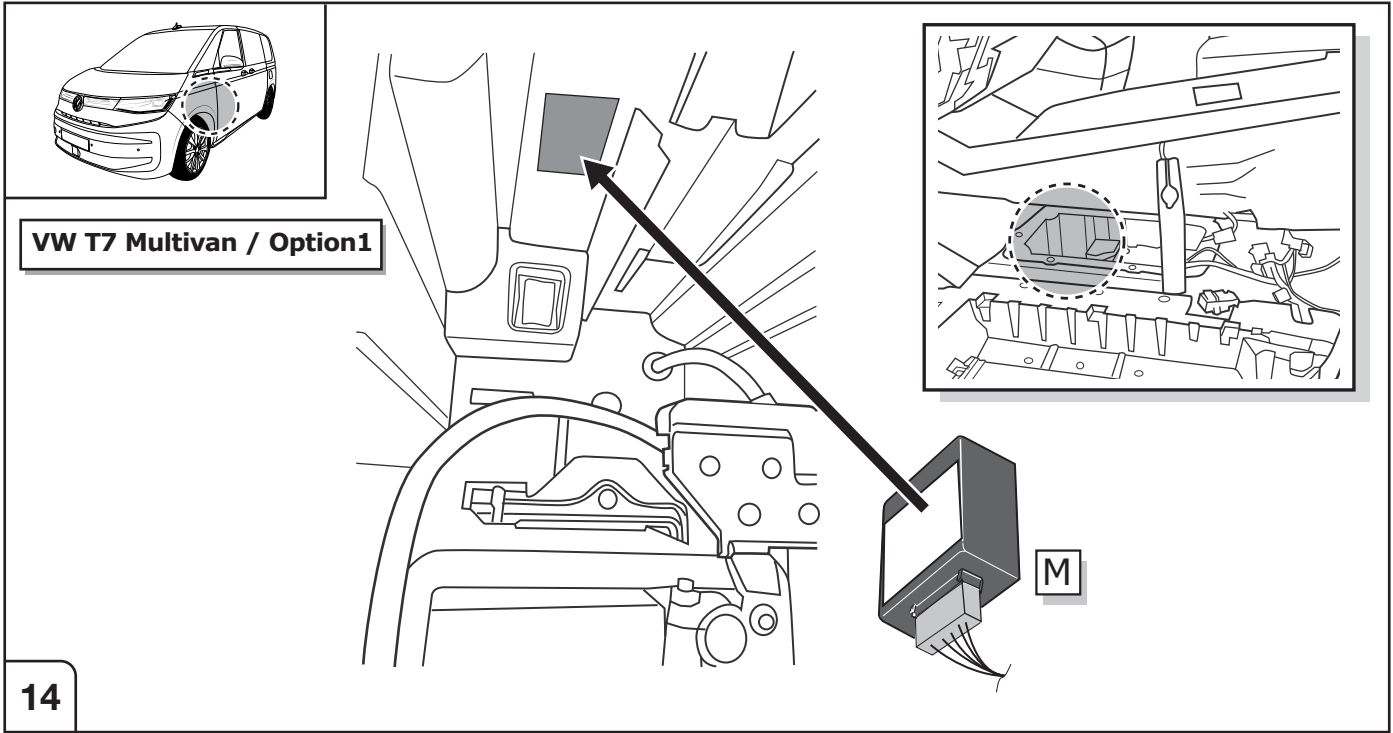

**FORD TOURNEO
& VW CADDY**

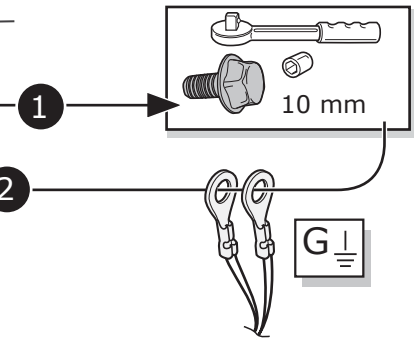
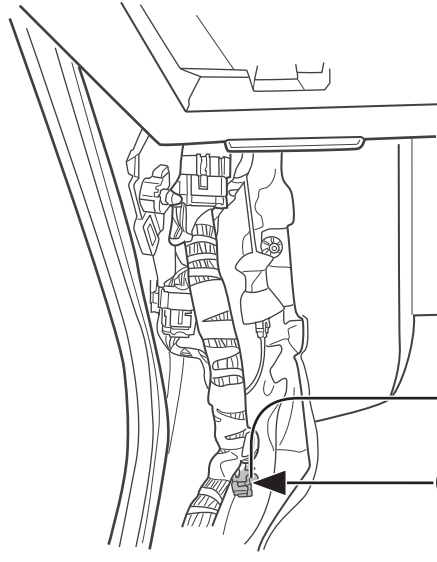
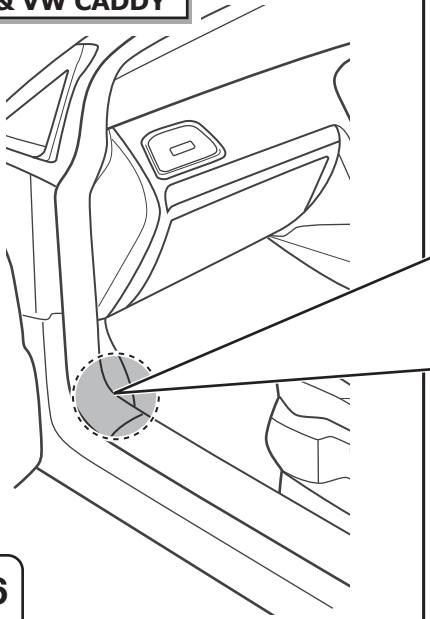

16



VW T7 Multivan

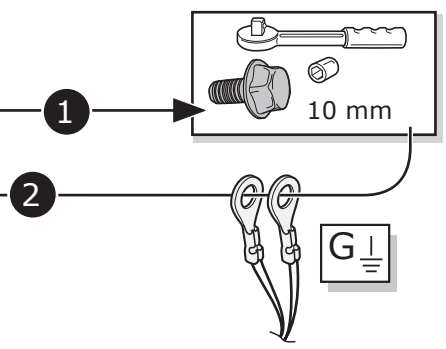
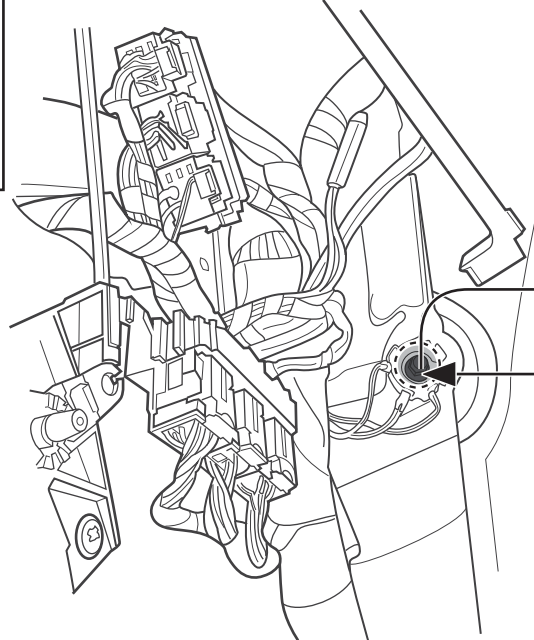

17

**FORD TOURNEO
& VW CADDY**

Body Control Module

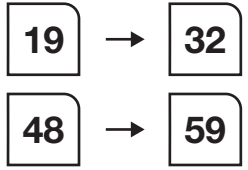
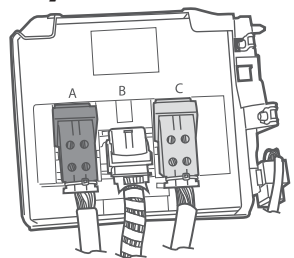

18

VW T7 Multivan

Body Control Module

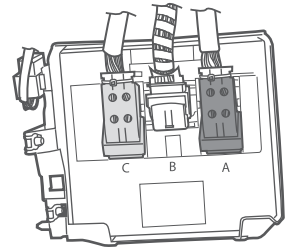

**FORD TOURNEO
& VW CADDY**

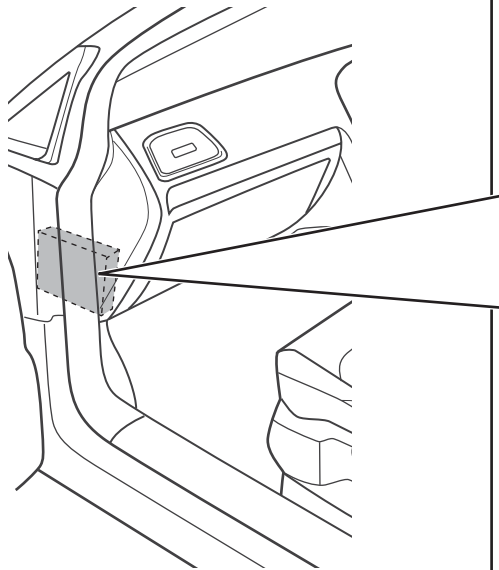

Body Control Module

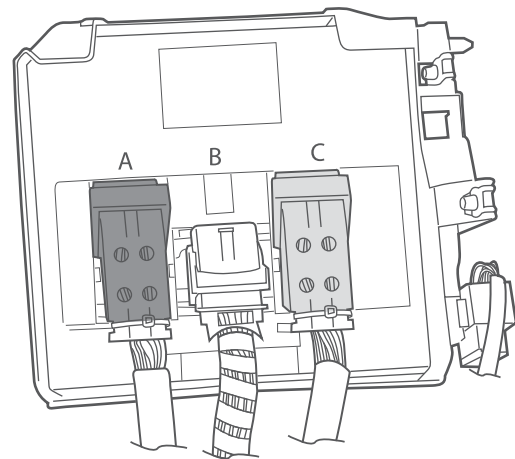

19

**CANbus
OPTION A**

With 1x

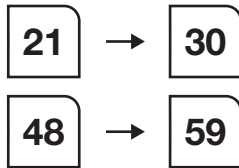

**CANbus
OPTION B**

With 3x

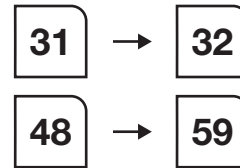

20

**CANbus
OPTION A**

Body Control Module

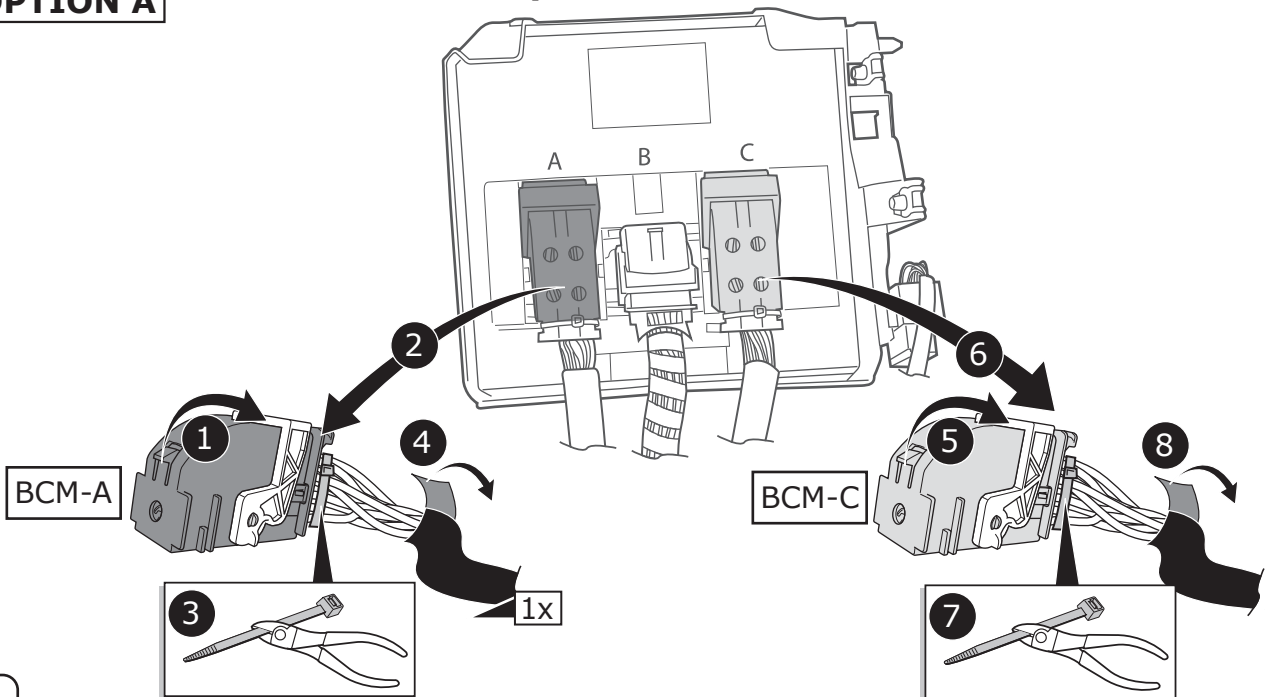

21

CANbus
OPTION A

BCM-A

2

3

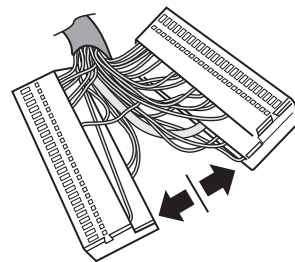
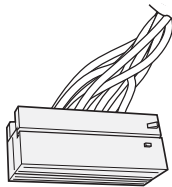
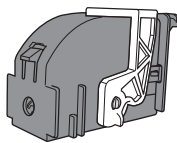
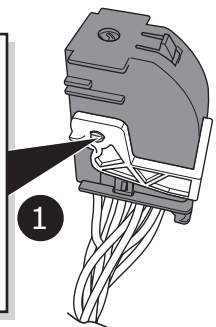
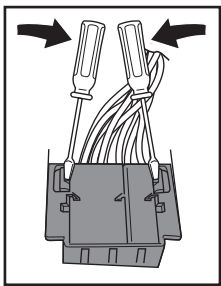

22

CANbus
OPTION A

BCM-A

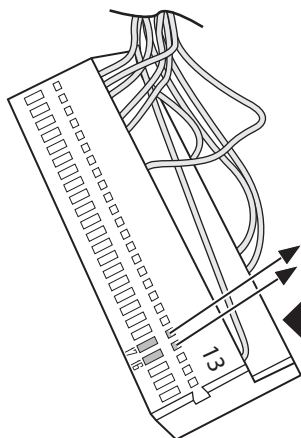

CAN L Orange/Brown
Pos. 17

CAN H Green
Pos. 16

Can-bus
Datawire

23

CANbus
OPTION A

BCM-A

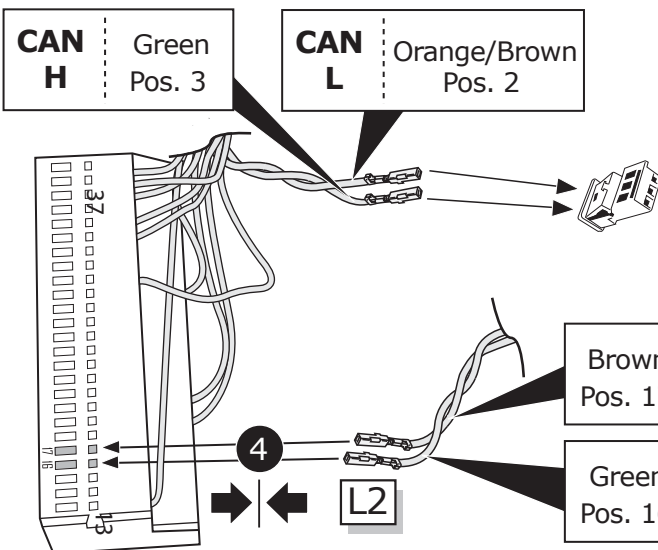

CAN H Green
Pos. 3

CAN L Orange/Brown
Pos. 2

Brown
Pos. 17

Green
Pos. 16

Can-bus
Datawire

24

CANbus
OPTION A

BCM-A

1

2

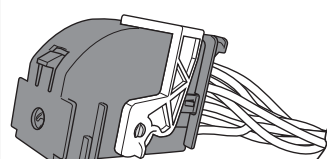
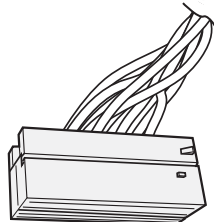
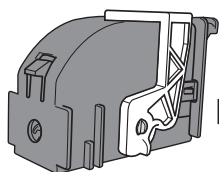
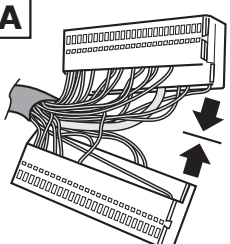

25

CANbus
OPTION A

BCM-C

2

3

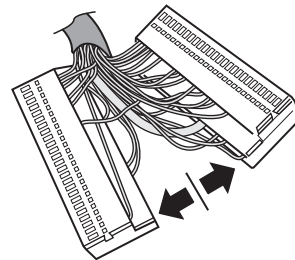
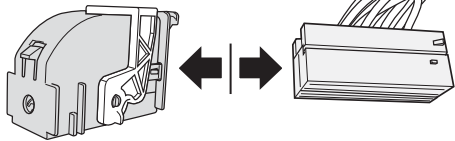
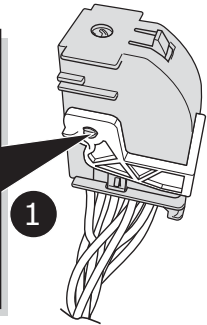
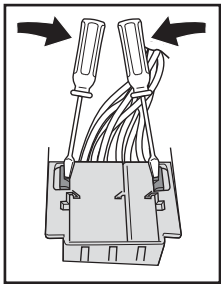

26

CANbus
OPTION A

BCM-C

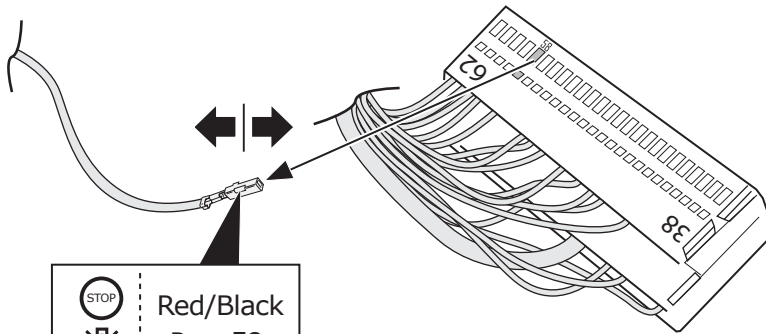

27

CANbus
OPTION A

BCM-C

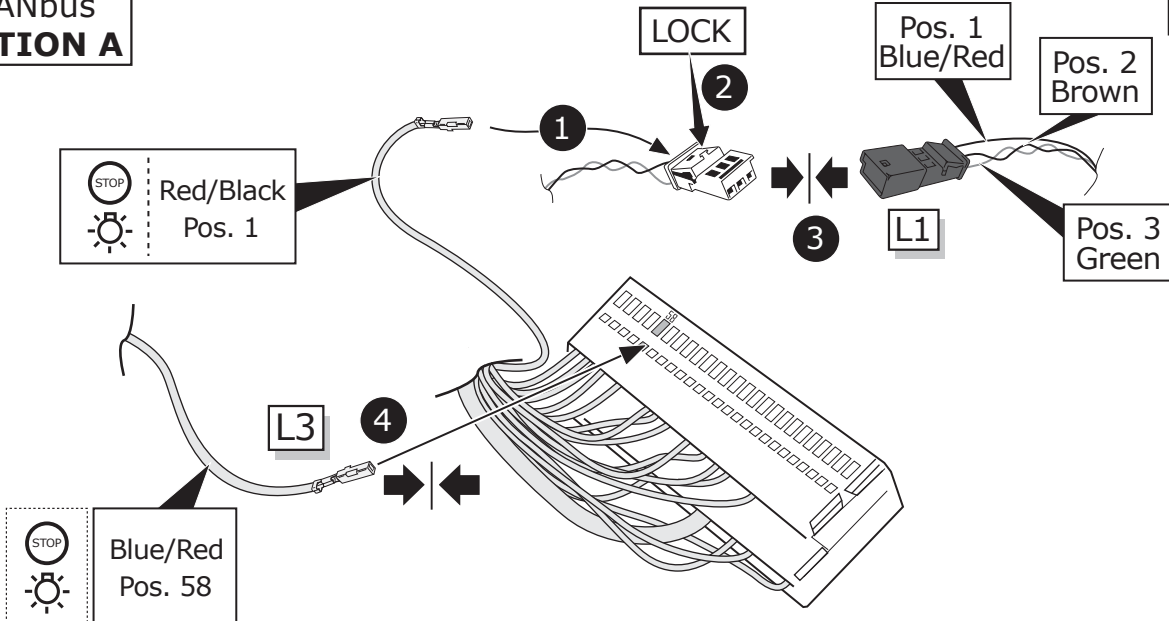

28

CANbus
OPTION A

BCM-C

1

2

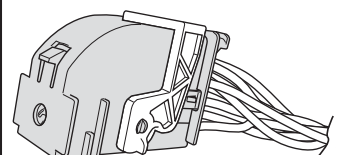
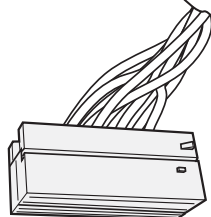
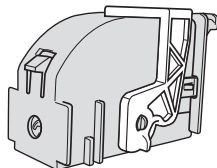
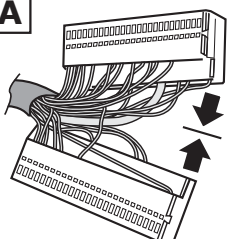

29

CANbus
OPTION A

Body Control Module

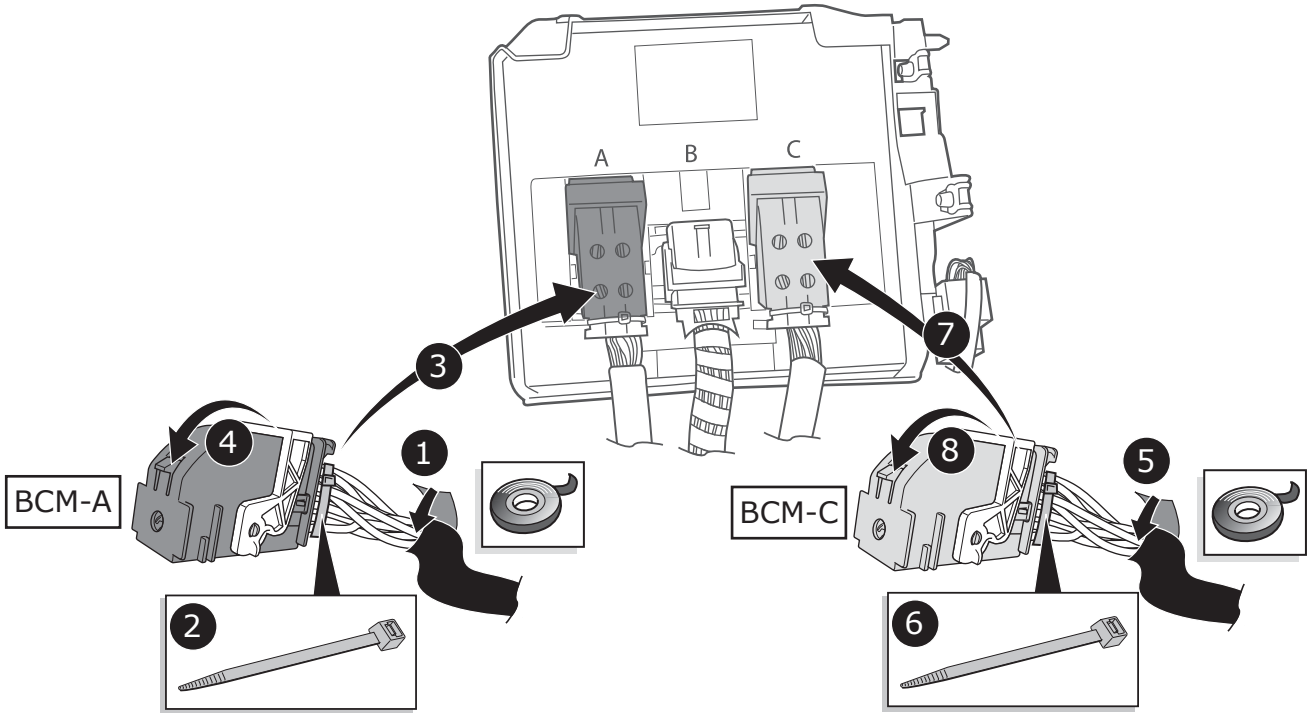

30

CANbus
OPTION B

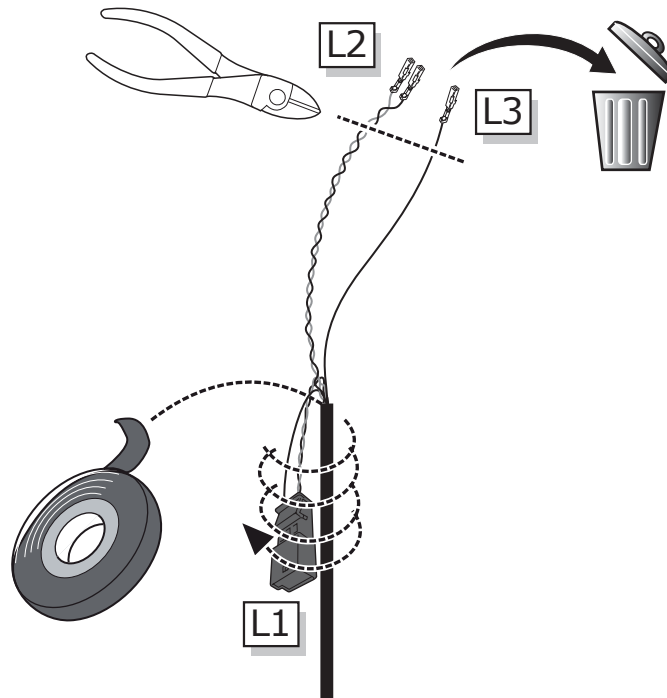

31

**CANbus
OPTION B**

Body Control Module

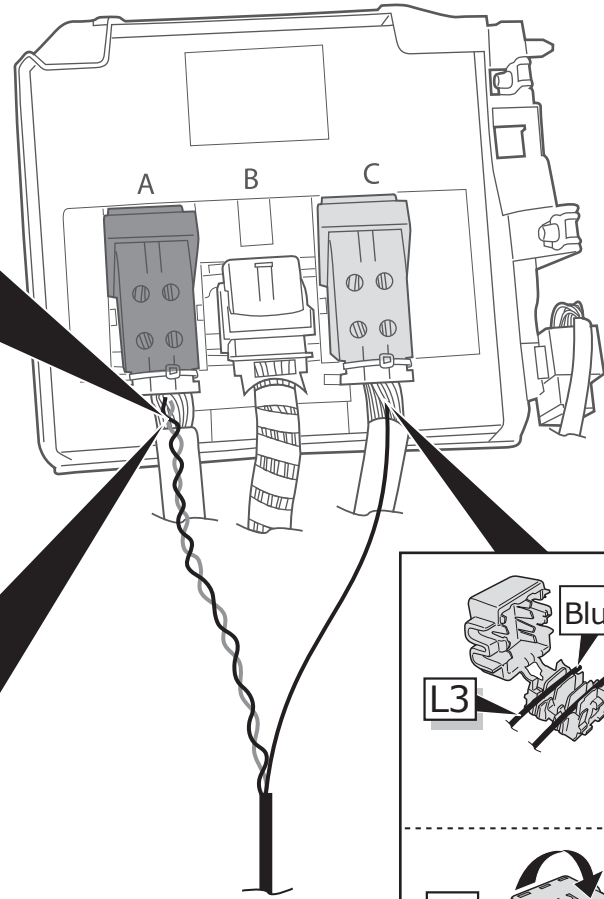
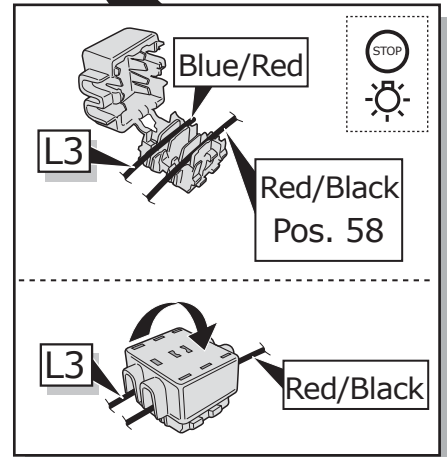
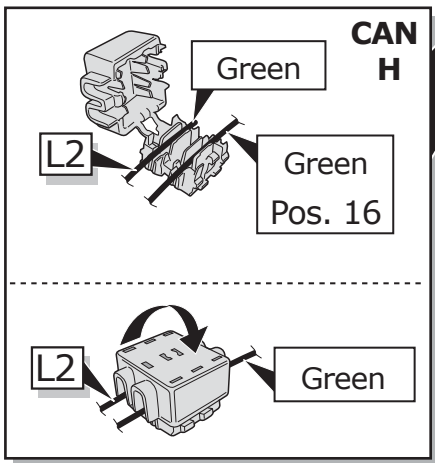
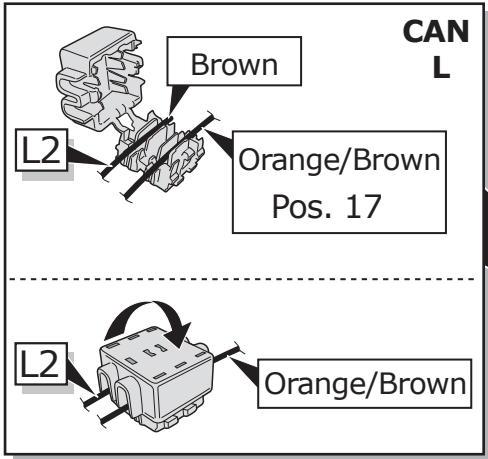

32

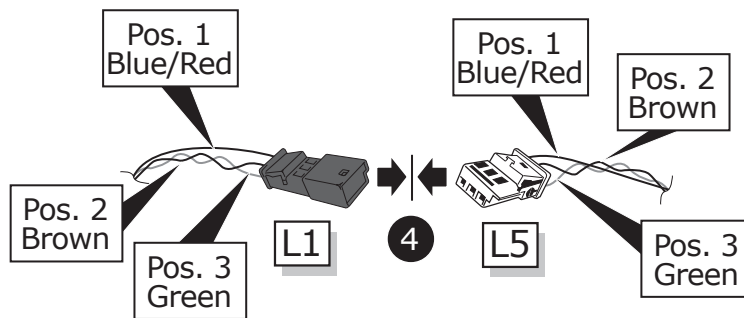
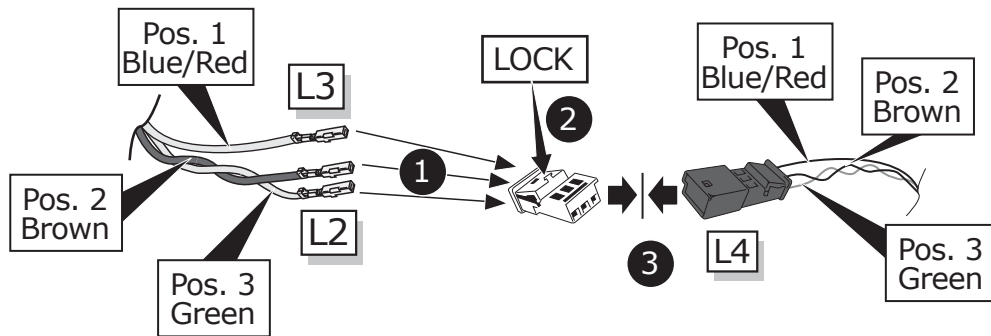

33

VW T7 Multivan

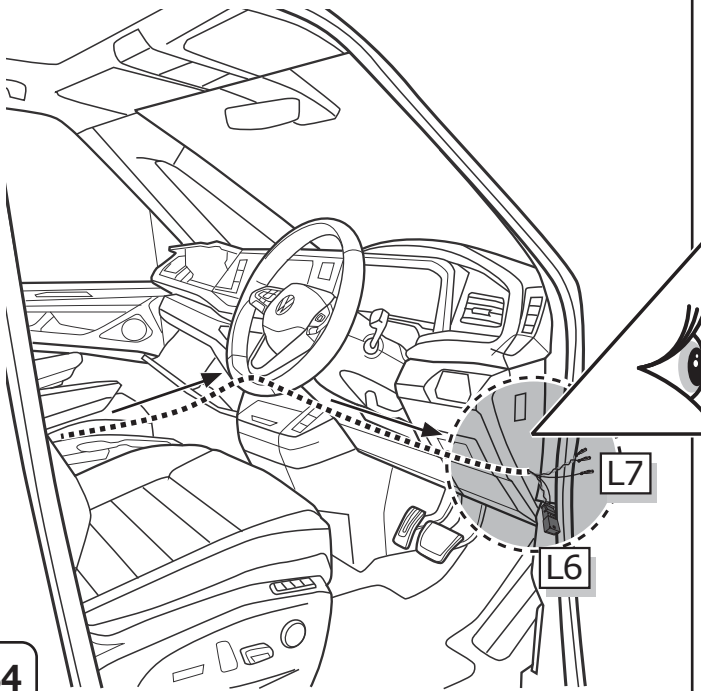

Body Control Module

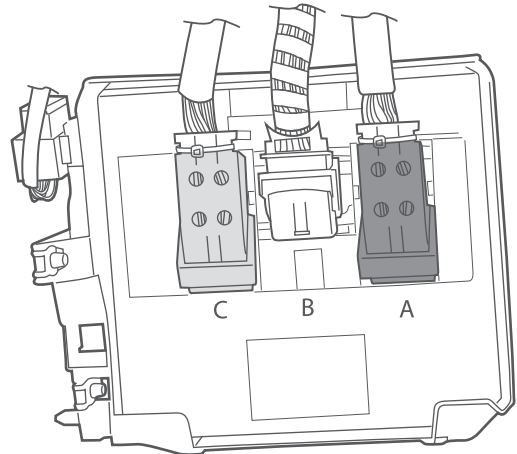

34

CANbus OPTION A

With 1x

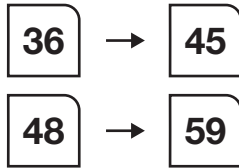

CANbus OPTION B

With 3x



35

CANbus OPTION A

Body Control Module

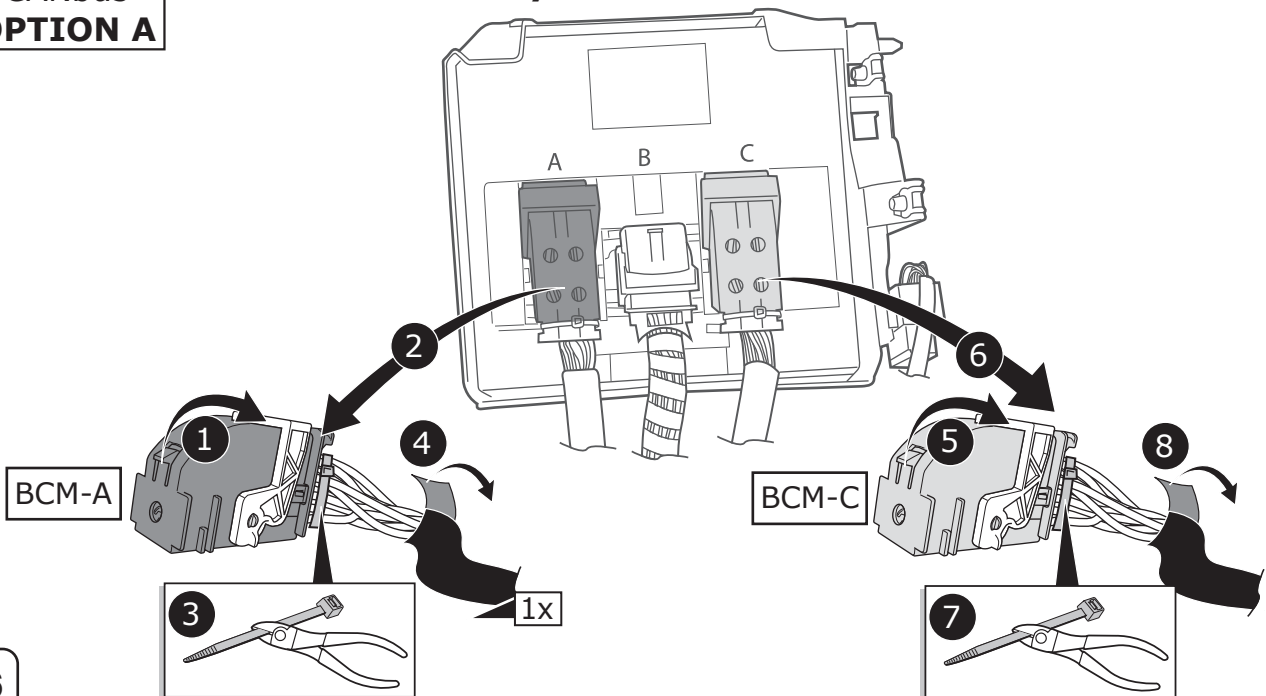

36

CANbus
OPTION A

BCM-A

2

3

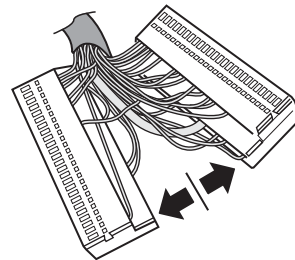
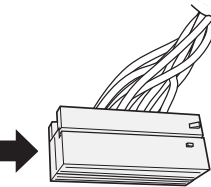
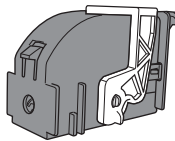
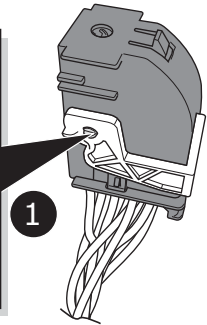
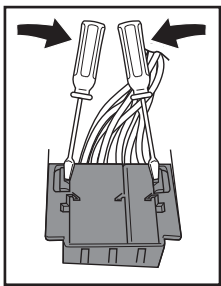

37

CANbus
OPTION A

BCM-A

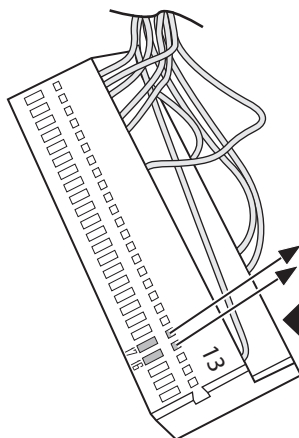

CAN L	Orange/Brown Pos. 17
CAN H	Green Pos. 16

Can-bus
Datawire

38

CANbus
OPTION A

BCM-A

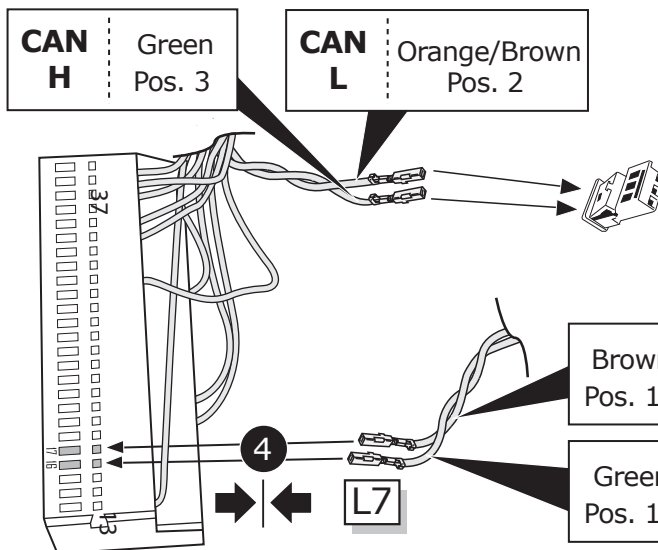

39

CANbus
OPTION A

BCM-A

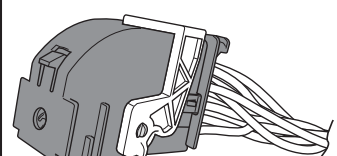
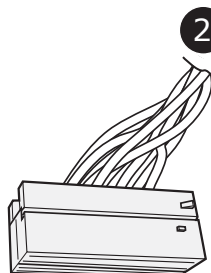
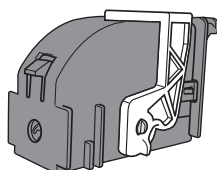
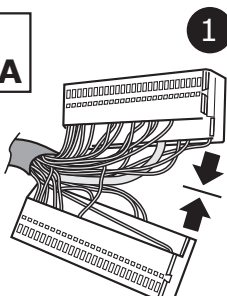

40

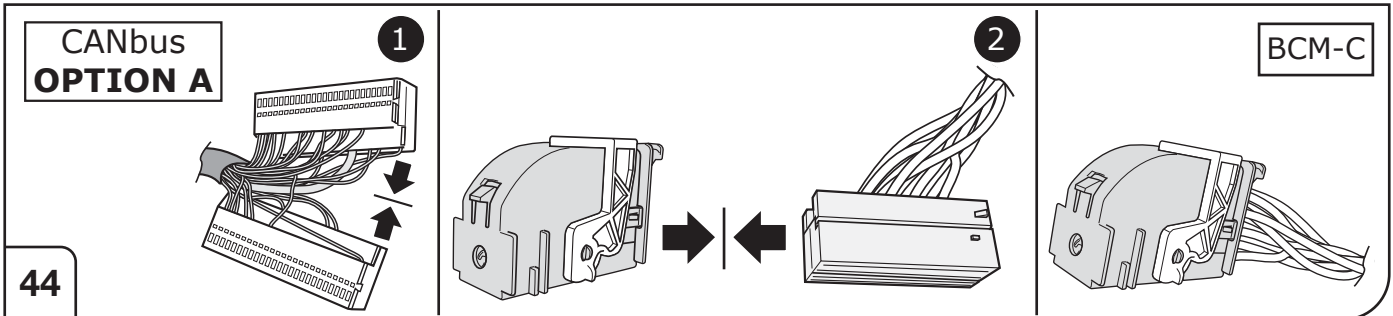
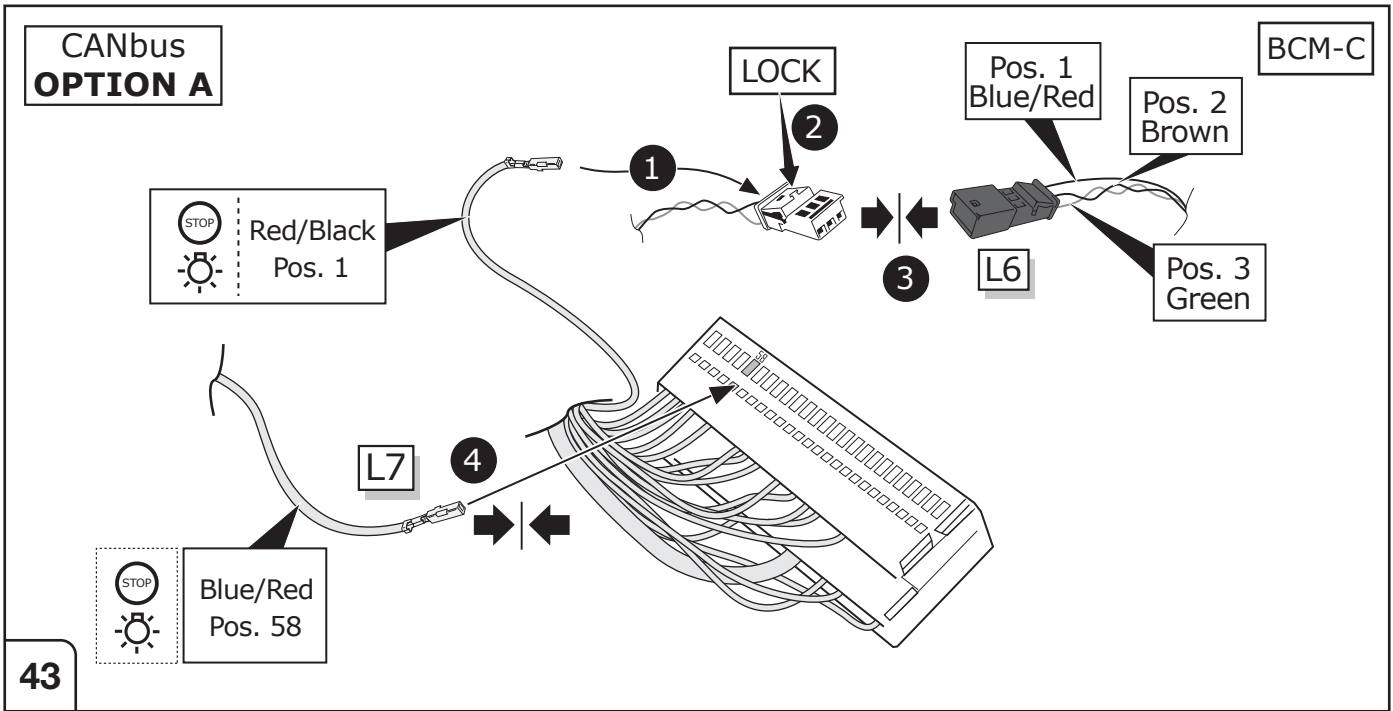
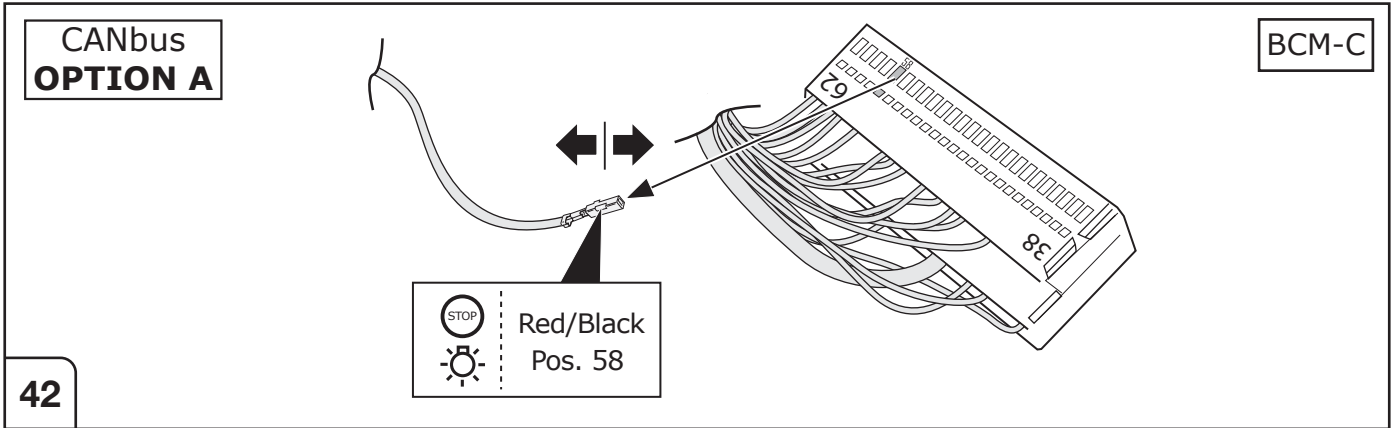
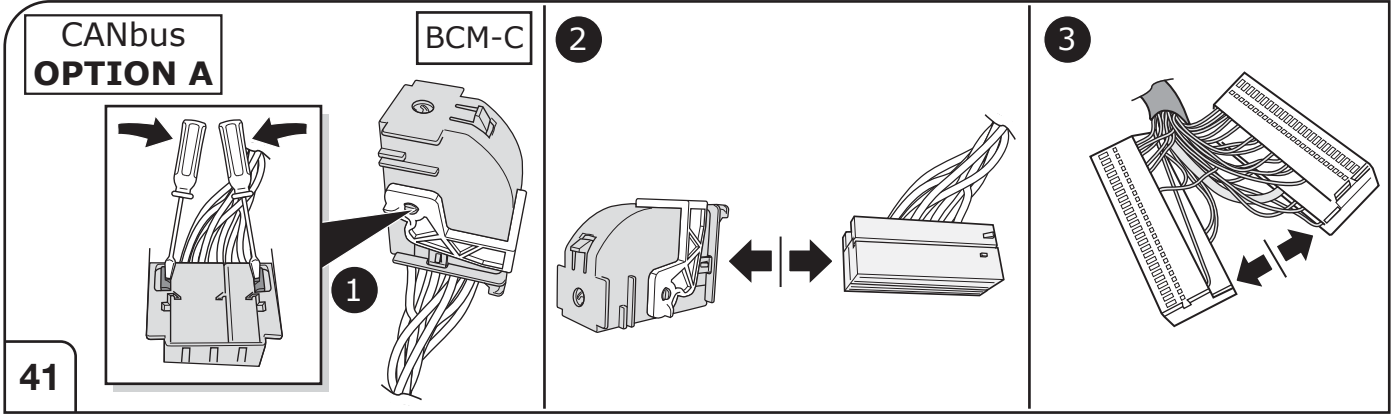

CANbus
OPTION A

Body Control Module

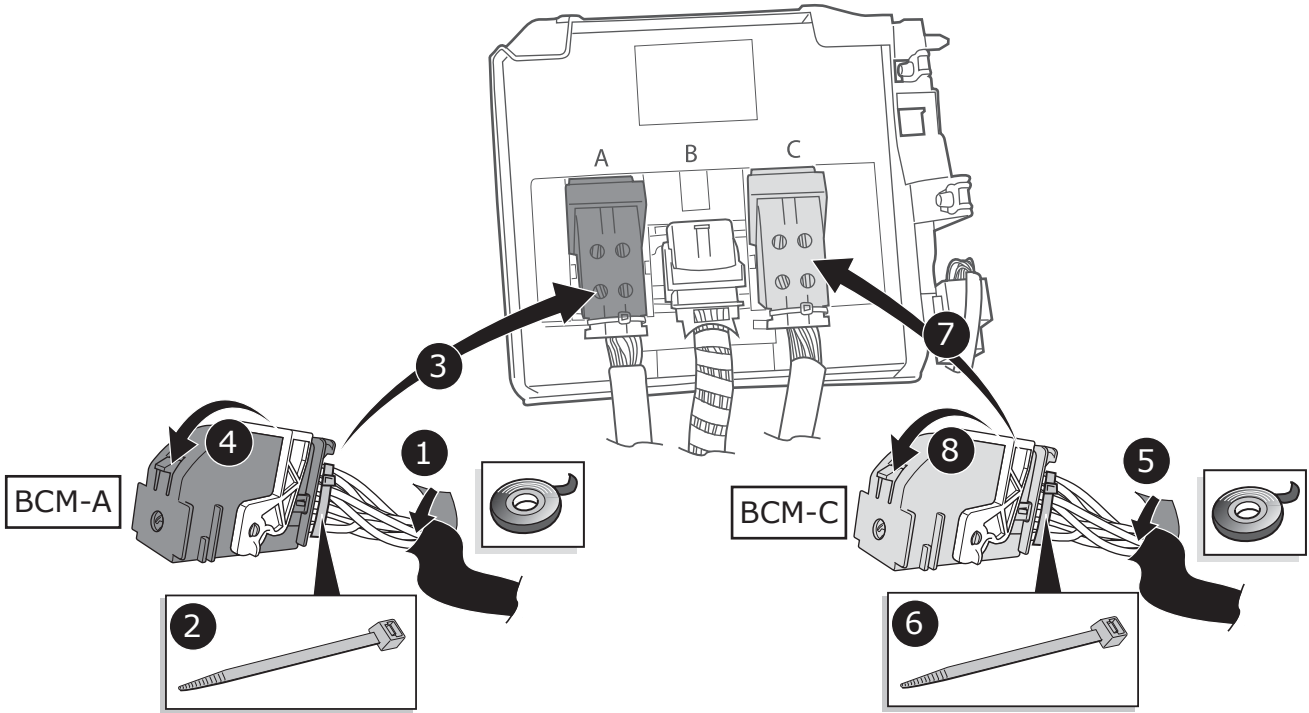

45

CANbus
OPTION B

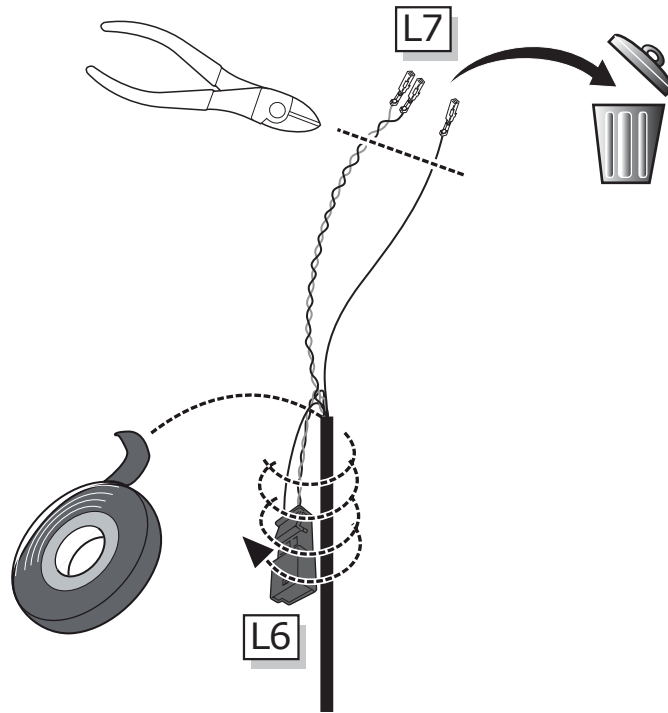

46

**CANbus
OPTION B**

Body Control Module

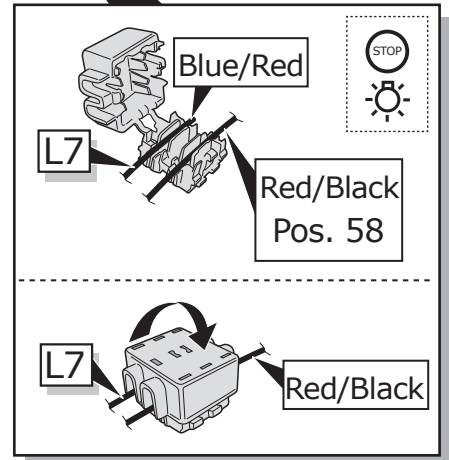
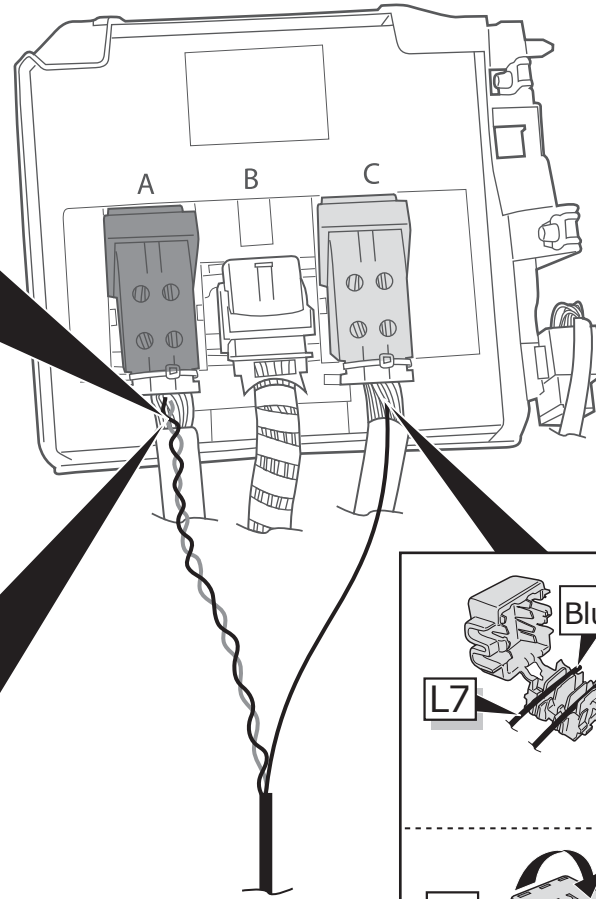
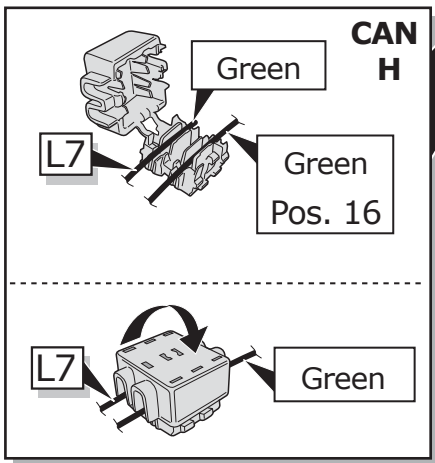
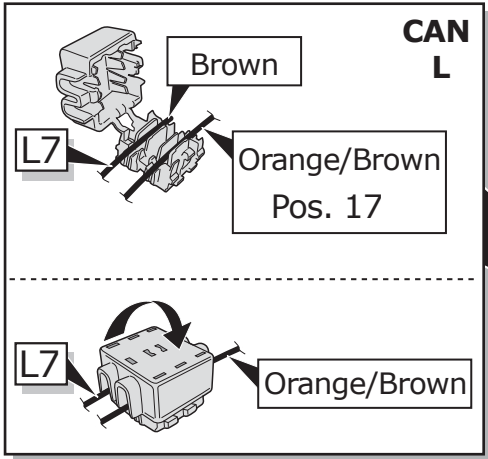

47

**B+/30
OPTION A**

Only B+/30 for module needed!

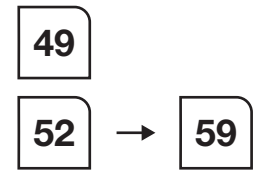
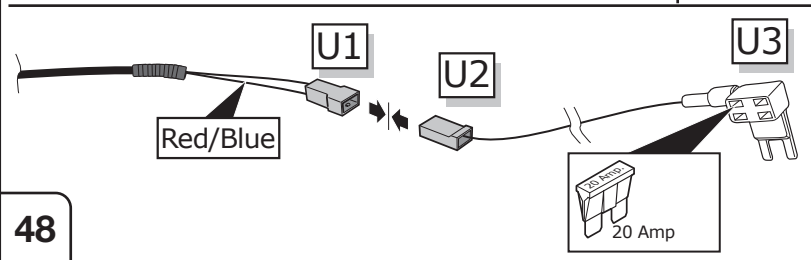
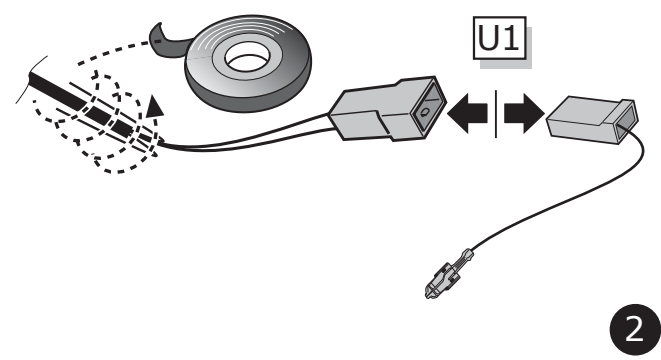
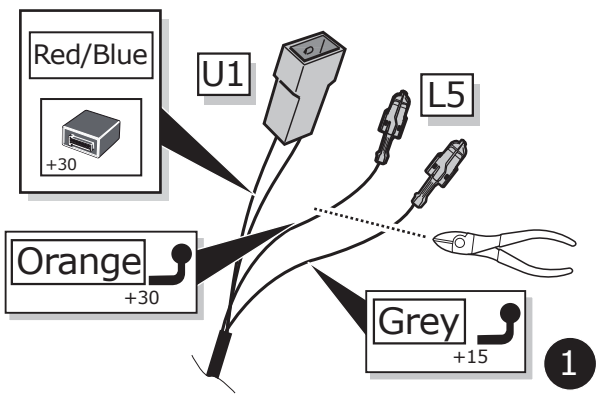

48

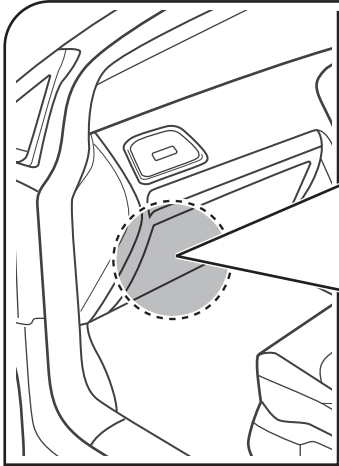

**B+ /30
OPTION A**

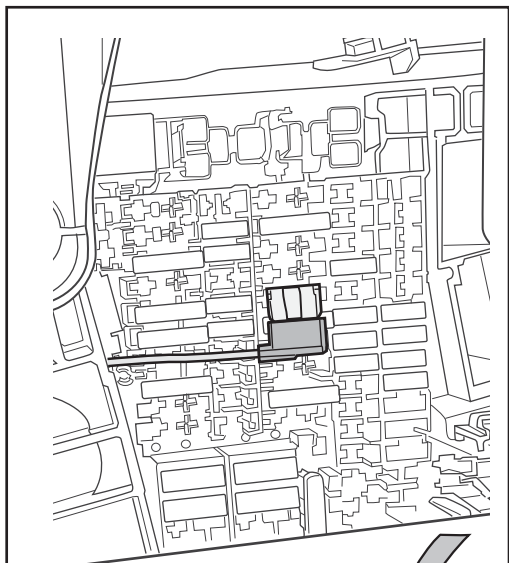
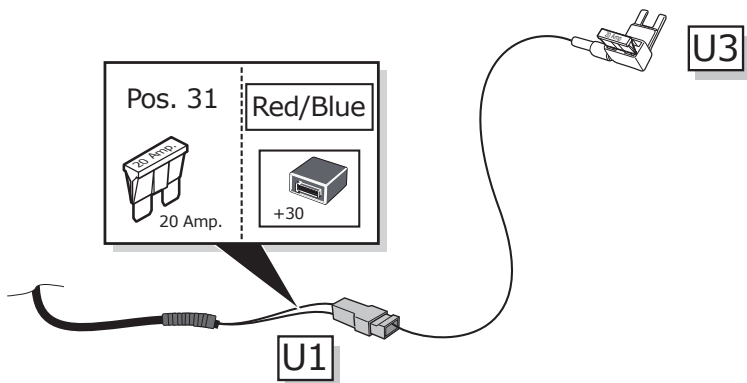
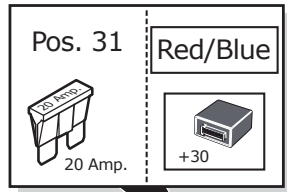
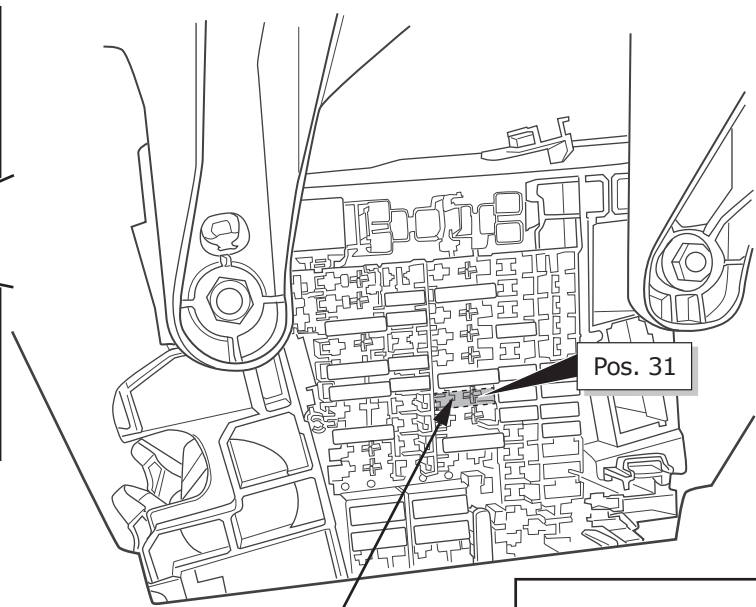

!
Important!
Please do not mount the
fuse tap and its wiring output
in the other direction!

49

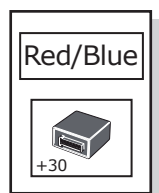
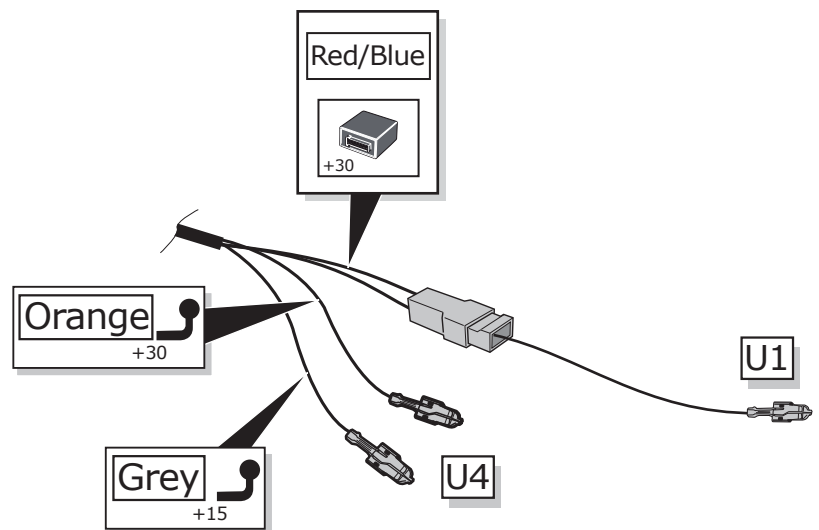

**B+ /30
OPTION B**



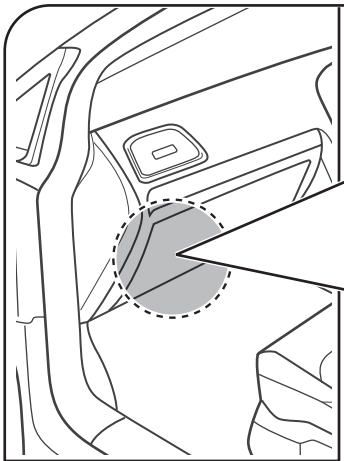



50



**B+/30
OPTION B**

Pos. 29	Orange
 15 Amp.	

Pos. 65	Grey
 15 Amp.	

Pos. 31	Red/Blue
 20 Amp.	

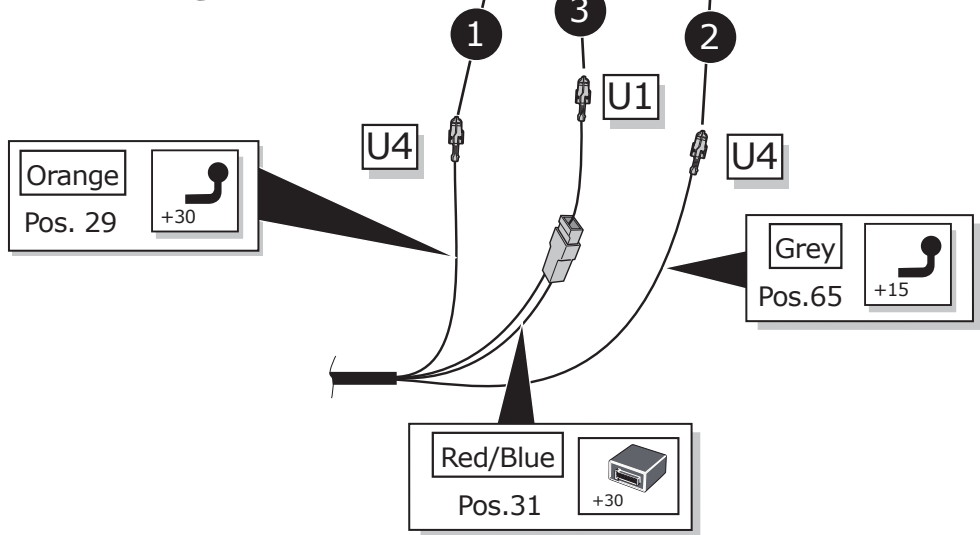
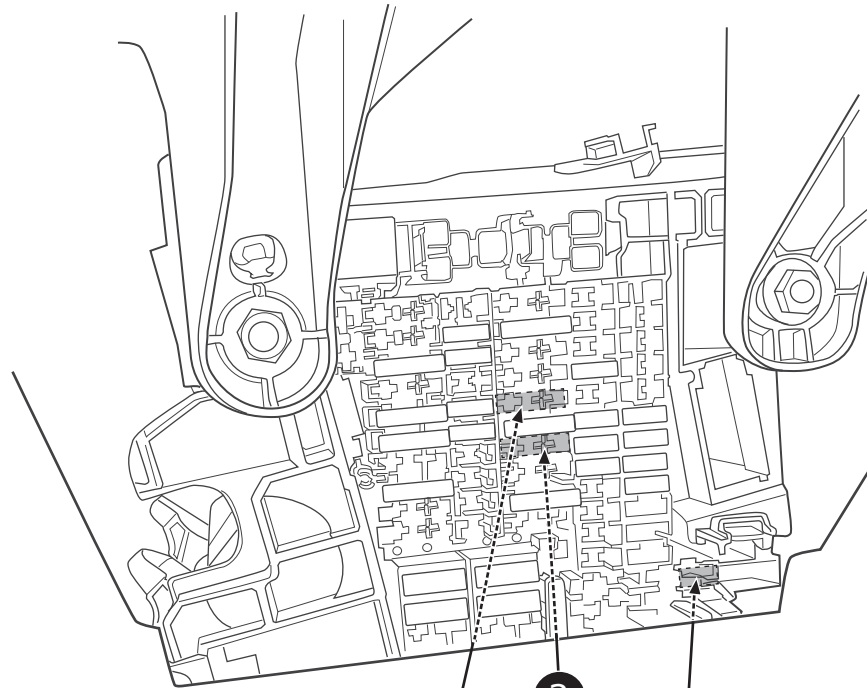

51

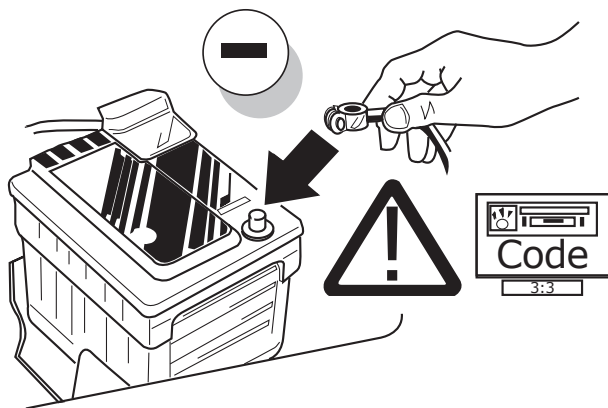

52

Set up trailer operation

VW CADDY
VW T7 Multivan

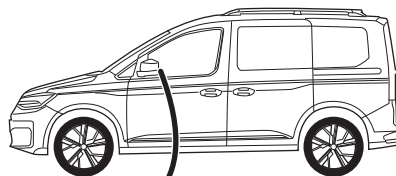
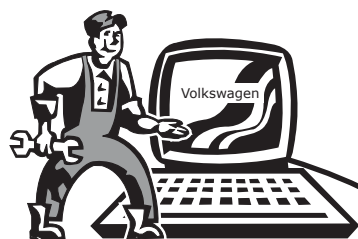

Complete Diagnostics

remote diagnostic & coding solutions

Call Hotline +44 (0)1952 608 750 - Option 4

CODING WITH ODIS

Please note:

The procedure described below for encoding and enabling the trailer mode only serves for a general orientation and can vary greatly depending on the model (motorisation / equipment). If necessary less or further control units will have to be adapted.

After connecting to ODIS, the "69 trailer function" controller has to be set to encoded in the target installation list.

The following may be necessary in the further course of work:

EZE_09 (electronic central electric controller):

Diagnosis
(possible login code: 31347)
Networking plan
Controller self-diagnosis
Encode
Trailer connection device >installed
or: hitch_ecu >installed

Alternative encoding EZE_09 as follows (MY 2017 >>):

Self diagnose control unit
Access authorization >31347
Adjustment
Integration
Trailer control unit > installed

ZKS_46 (Central module convenience system)

trailer monitoring >put on active
trailer control unit >installed

SWA_3C (Lane Change Assist)

ECU for draw bar >with ECU for draw bar

SW2_CF (Lane Change Assist2)

ECU for draw bar >with ECU for draw bar

SCH_17 (Dash panel insert)

Trailer >yes

RFK_6C (reverse camera system)

equipment_ahk >installed

STF_74 (chassis control system)

Trailer >installed

EPH_76 (PDC controller)

Trailer >trailer device can be removed manually

DIS_13 (controller distance control)

(possible login code: 20103)
Control module for towing sens >installed

Alternative encoding DIS_13 as follows:

Self diagnose control unit
Access authorization >20103
Encoding
Binary encoding
Byte 3
Binary >xxxx1xxx
or Hex >+8

03 Brake electronics

Access authorisation > 61378
Adjustments
Trailer stability >Active

FFF_A5 (front sensor system controller)

AAG >coded

HDE_6D (boot lid electronics controller)

Trailer >installed

Encoding AST_7E (Driver display unit)

Encoding
Trailer → on

Important note on encoding and activating in trailer mode

The aforementioned settings are carried out in the vehicle's electrical system and saved locally. During general updates for the vehicle software (for example, within the scope of service or repair work), the settings may be overwritten and deleted under certain circumstances. In this case, the trailer mode activation has to be updated again locally after the update. Diagnostic information relating to the trailer mode that may appear during variance comparisons with the data saved in the manufacturer's works, may form the basis of the local activation.

Set up trailer operation

FORD TOURNEO

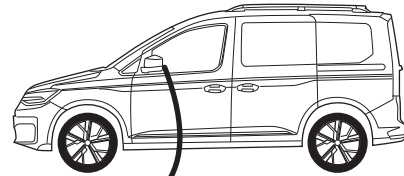
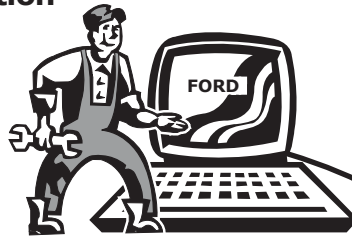

Complete Diagnostics

remote diagnostic & coding solutions

Call Hotline +44 (0)1952 608 750 - Option 4

Please connect the vehicle to FDRS (Ford Diagnostic & Repair System) or Jifeline diagnostic, initiate the trailer coding procedure and follow the instructions!

Use the following configuration codes in the FDRS Trailer Tow App.:

Vehicles with trailer coupling pre-pack and fixed trailer coupling: **364B**
Vehicles with trailer coupling pre-pack and detachable trailer coupling: **364C**

Vehicles without trailer coupling pre-pack and fixed trailer coupling: *

Vehicles without trailer coupling pre-pack and detachable trailer coupling: *

54

***Ask your local Ford dealer for the corresponding configuration code or use the Jifeline diagnostic network!**

Optional

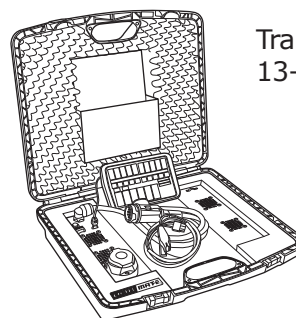

Trailer Simulator for 7- and 13-pin Sockets

55

Functional test

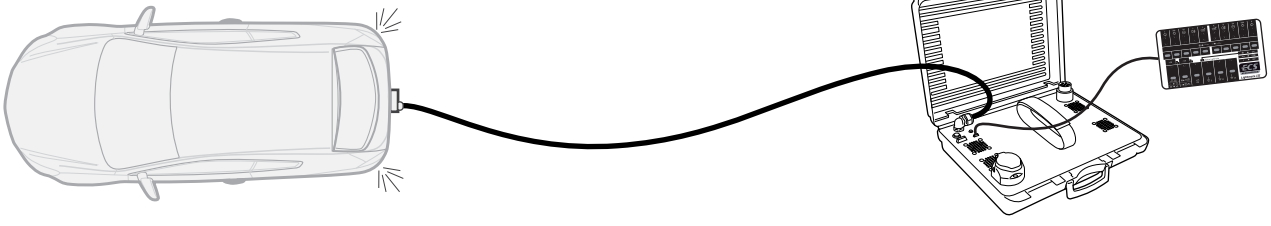
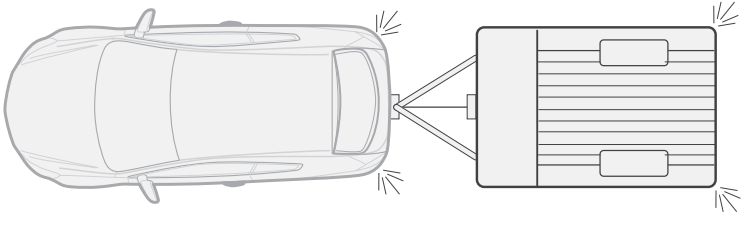
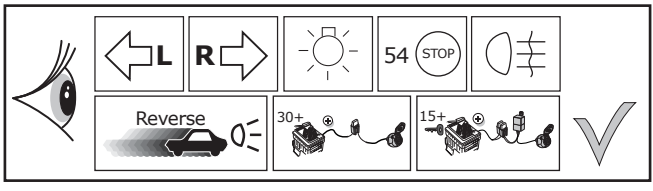

56

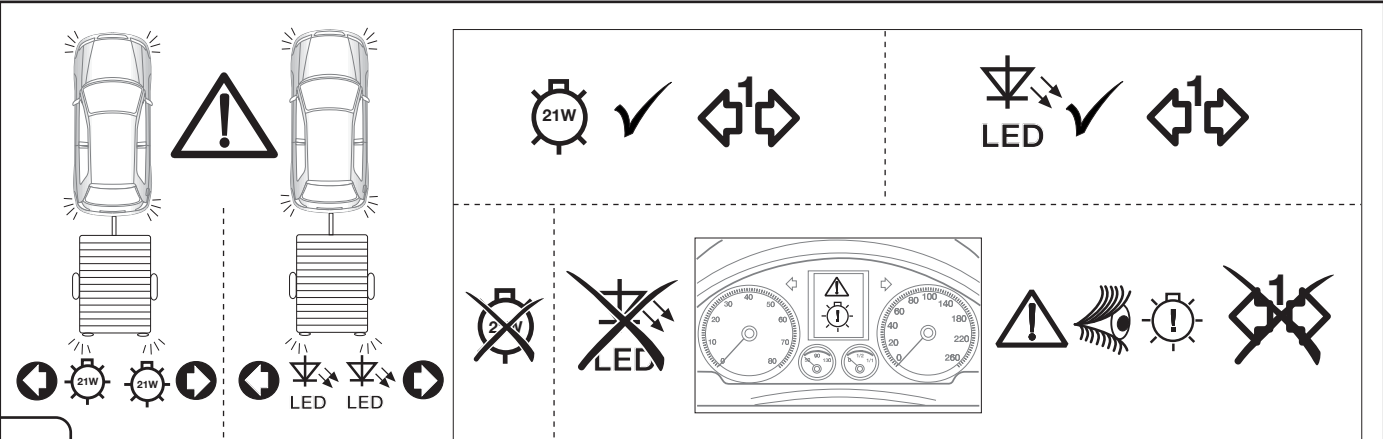

57

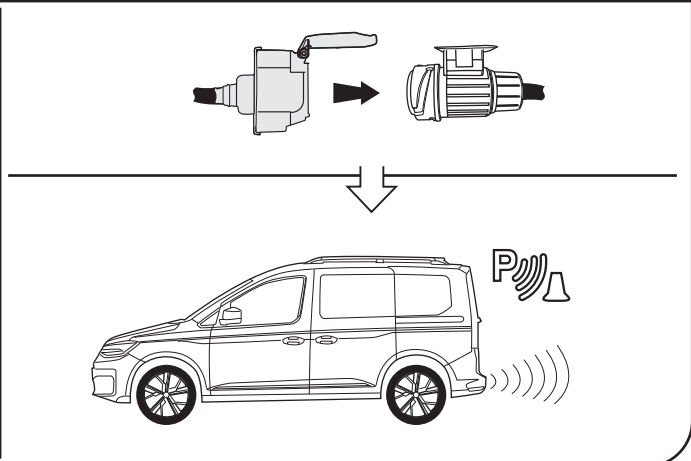
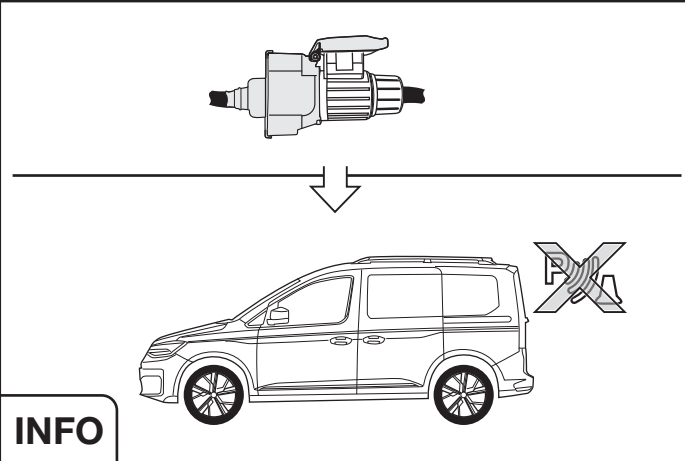

INFO

The following light functions for the trailer are not **supported** by all towing vehicles **with DRL circuit**:

- **Rear lights**
- **Side lights**
- **Numberplate lights**

The **taillights or dimmed headlights must be switched on** to activate this function!

INFO

Optional

Adapter socket

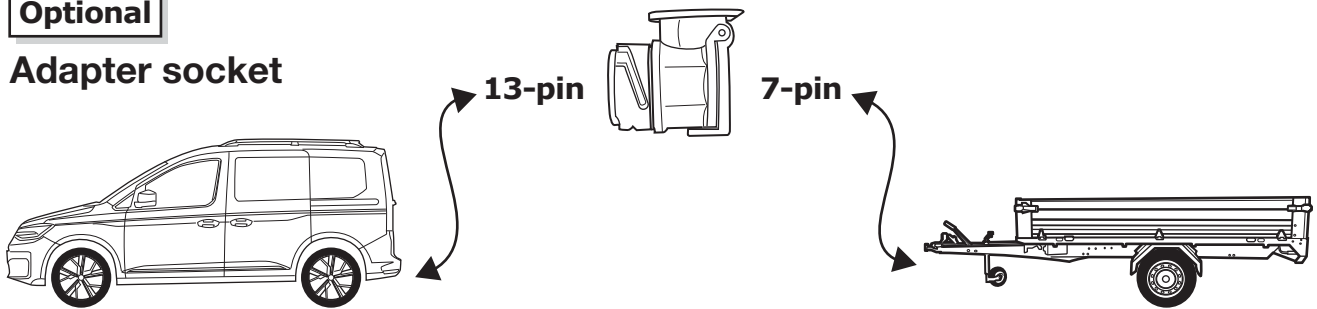

58

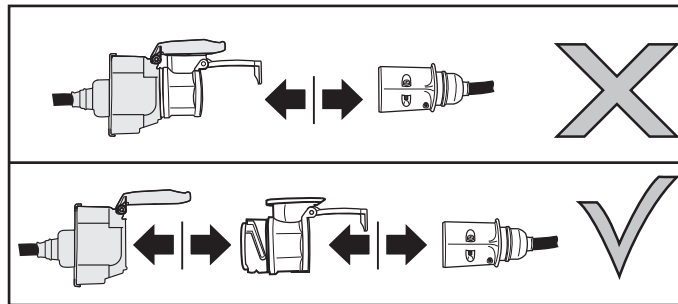
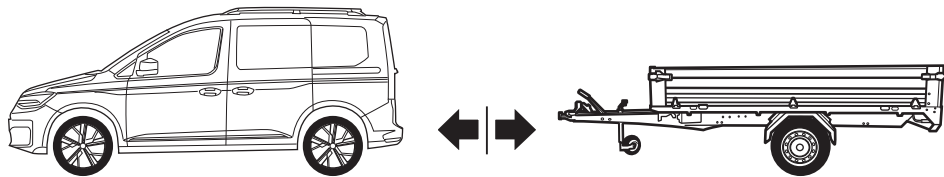

59

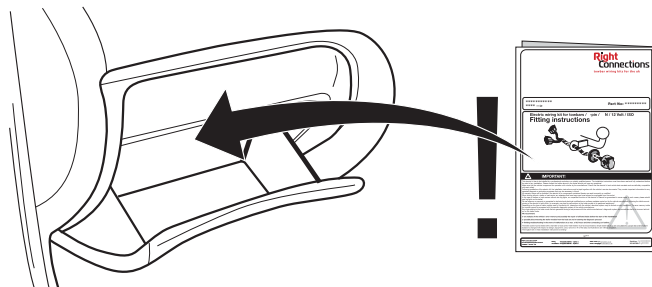

60

SOCKET CONNECTION

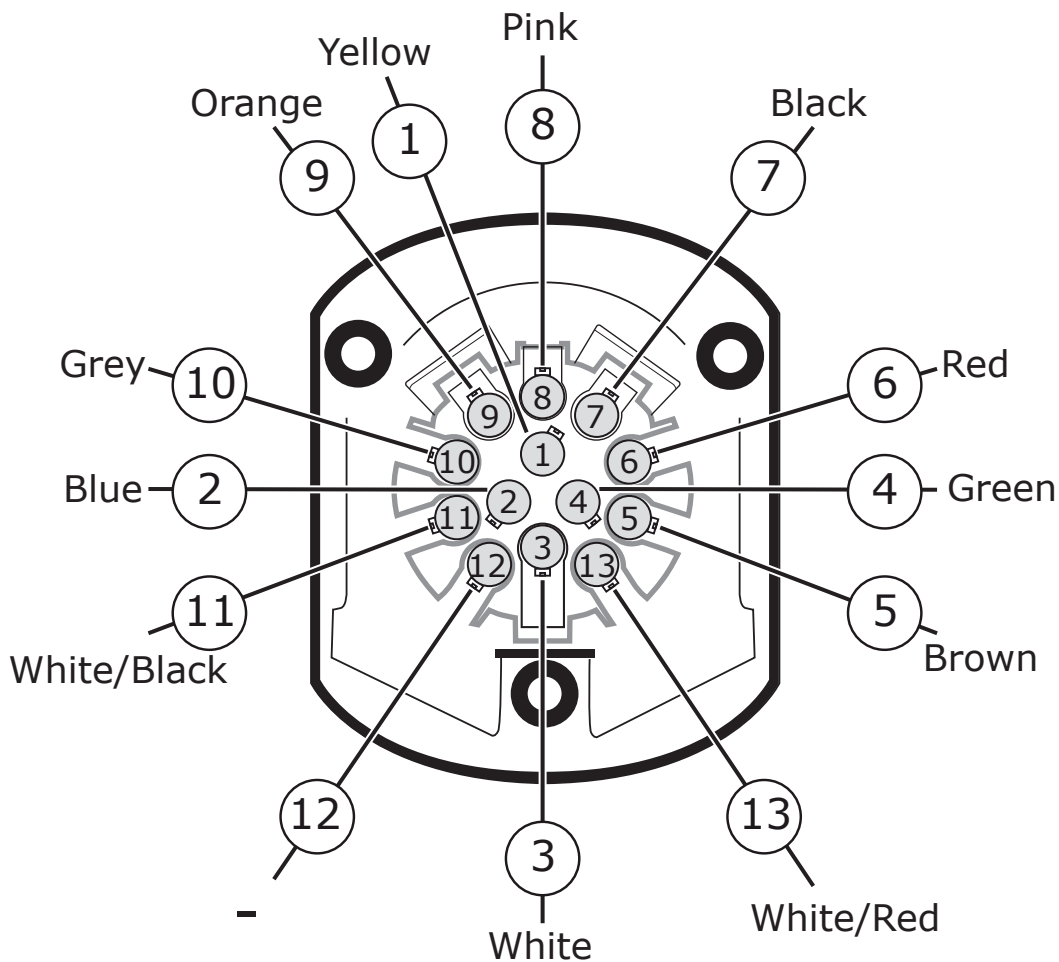

SOCKET CONNECTION

DIN/ISO 11446													
Pmax	21W	21W		21W	42W	3x21W	42W	21W	240W	180W			
Colour	Yellow	Blue	White	Green	Brown	Red	Black	Pink	Orange	Grey	White/Black	-	White/Red