

SUPPLIERS OF TOWBAR WIRING KITS FOR THE UK

BMW

X3 G01 11/2017 >>

X4 G02 07/2018 >>

Part No: BW-028-13

Electric wiring kit for towbars / 13-pin / 12 Volt / ISO 11446 Fitting instructions

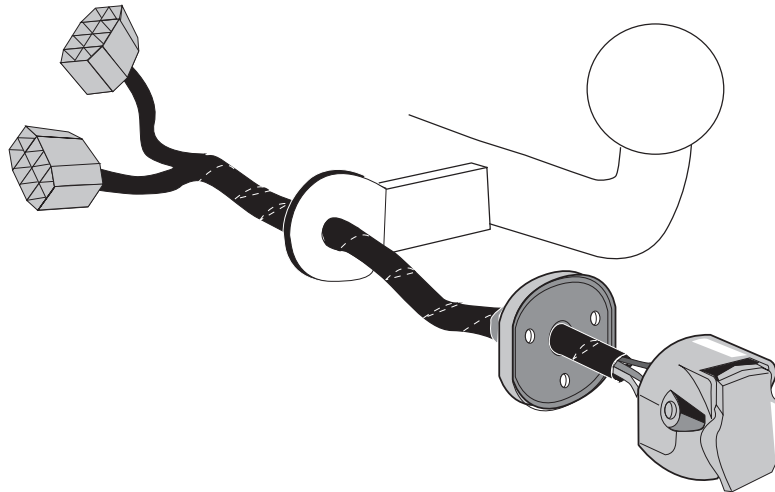

IMPORTANT!

This electric kit has to be installed by a professional workshop or a suitable qualified person.

The installation instructions must have been read and fully understood before the start of any installation. Please contact your wiring kit provider or the hotline shown in the footer should you need assistance!

Make sure the vehicle is approved/homologated by the manufacturer to tow a trailer!

Also please check that there is a definite compatibility between this vehicle and the electric kit!

Following the installation of the electric kit, the fitting instructions should be kept together with the vehicle service document and vehicle handbook. The fitting instructions contain important information relating to the use and function of the towing kit as well as for any diagnostic or activation process, that might have to be repeated in the future (e.g. after the performance of a vehicle software update).

All warranty claims will be forfeited if the electric kit or components contained therein are used incorrectly or modified. If a towing socket adaptor has been used to connect to the trailer or bike rack, this must be removed from the trailer socket once the trailer or bike rack has been disconnected.

If the trailer or bike rack is not equipped with a rear fog lamp, depending on the towing vehicle type, the correct function of the towing kit cannot be guaranteed. In such cases, a rear fog lamp should be retro fitted.

This towing electric kit will not be covered under warranty if any technical or electrical modifications or software updates have been performed by the vehicle manufacturer after the initial commissioning of the kit. That applies especially to modifications or updates which may cause malfunctions in the trailer socket or any other part of the trailer electrical equipment!

Depending on the type of trailer module used in this electric kit, diagnostic interrogation with the vehicle's electrical system may be limited or will not function. The error memory inside the trailer module may not be able to be accessed by vehicle manufacturers diagnostic system.

Error logs relating to the trailer electrical equipment, that may be generated in the vehicle manufacturers diagnostic system as a result of a test procedure, may be due to the incorrect installation of the towing electric kit or the false activation of the trailer module.

We always recommend whenever possible, the following troubleshooting process:

→ **An analysis of the vehicle's error memory and possibly clearing of all faults before the start of the installation!**

→ **Try disconnecting the trailer module from the towing harness and re-start the fault clearing process!**

→ **If in doubt, limit the time for troubleshooting to a max of 0,5 hours and call our Technical Support Team!**

Please follow our instructions carefully and always test the towing electrics using a true lighting board or a specifically designed bulb tester. If an LED tester is used, ensure it is equipped with correct load resistors or malfunctions will occur!

This instruction is subject to changes and we reserve the right to make changes to design, colour etc.

All of the data and illustrations may not be an exact representation but the text contained in this instruction must be observed!

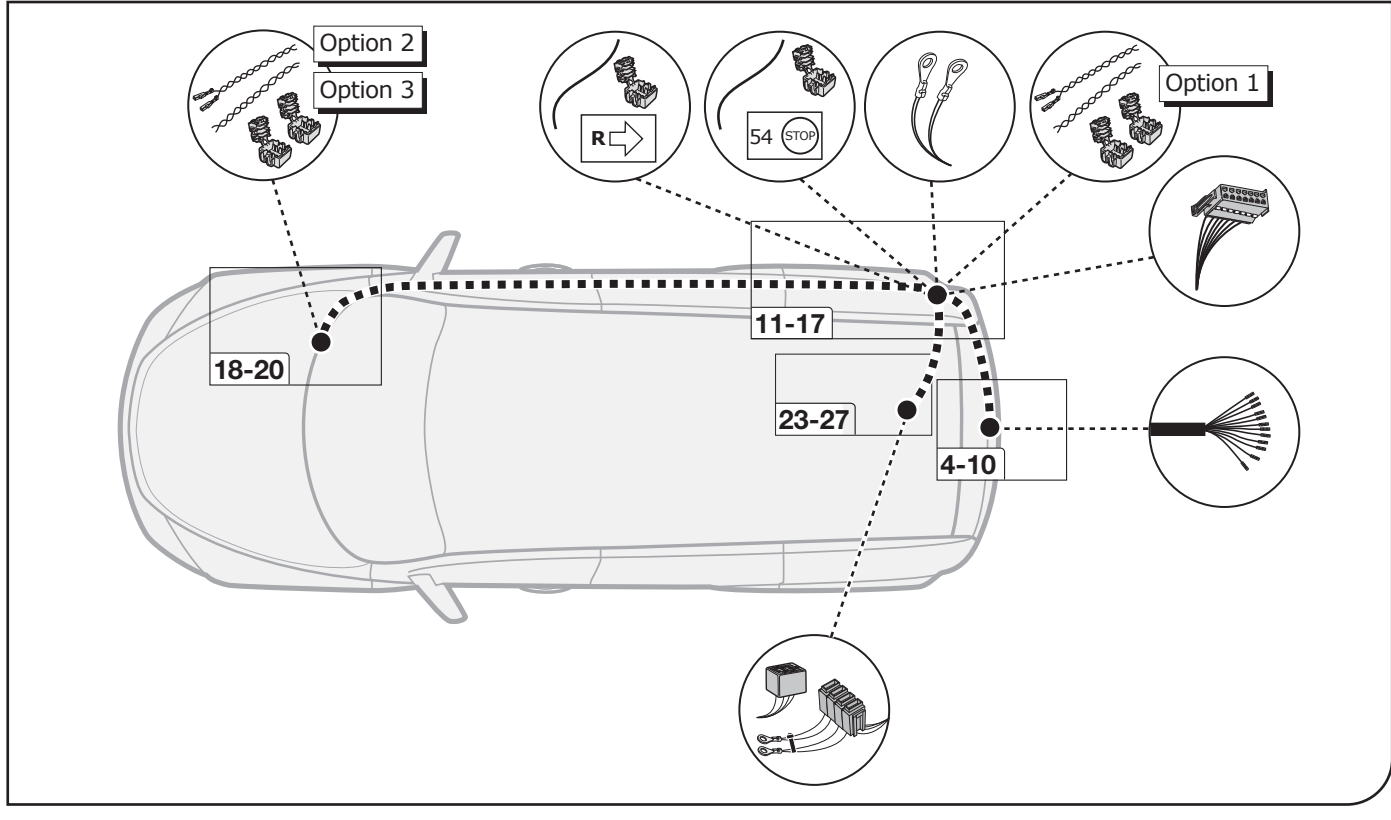
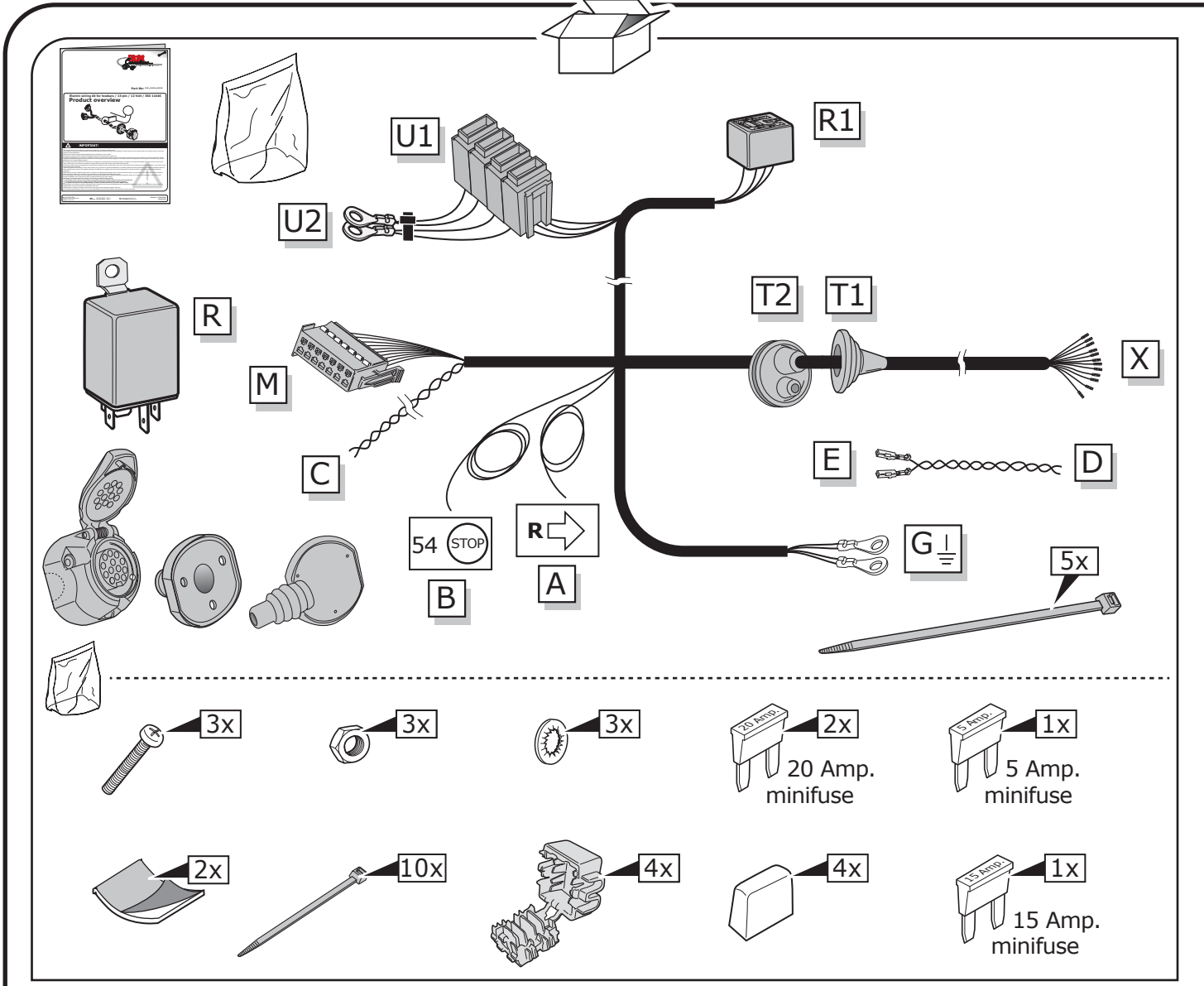

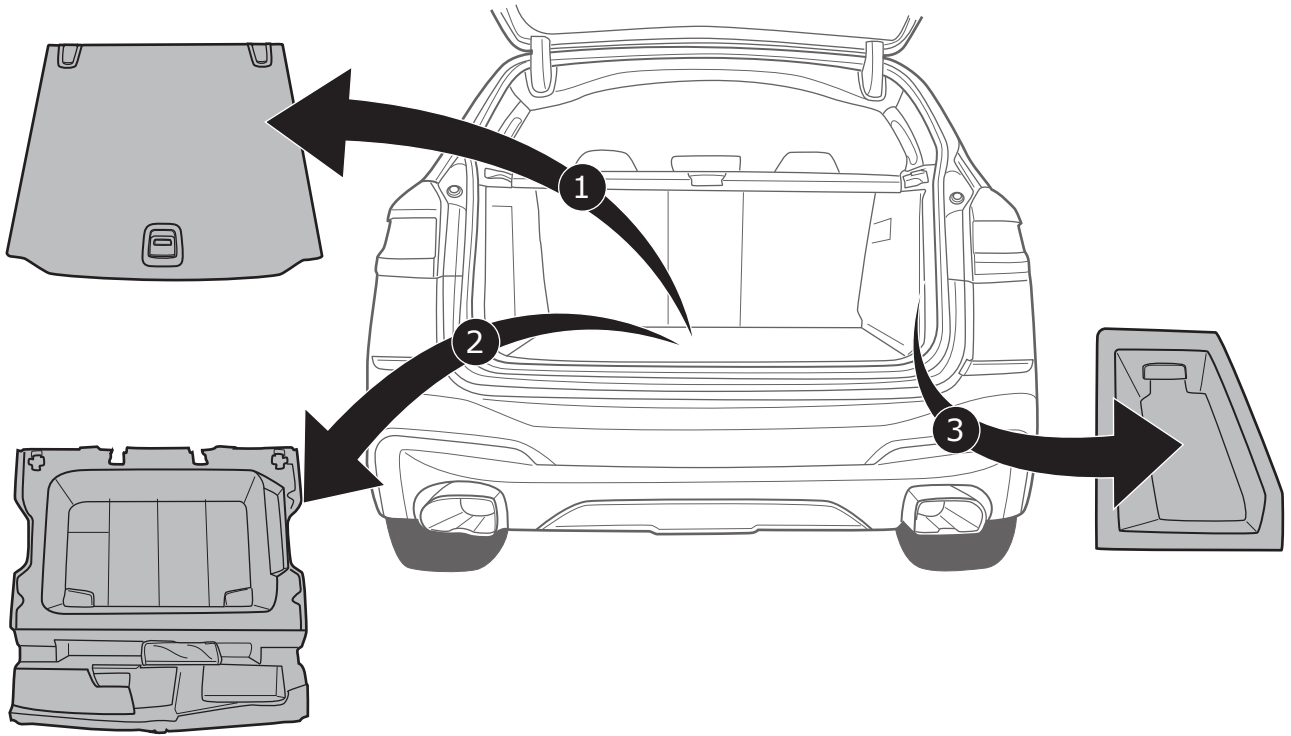

2

CAN Bus Option 2+3

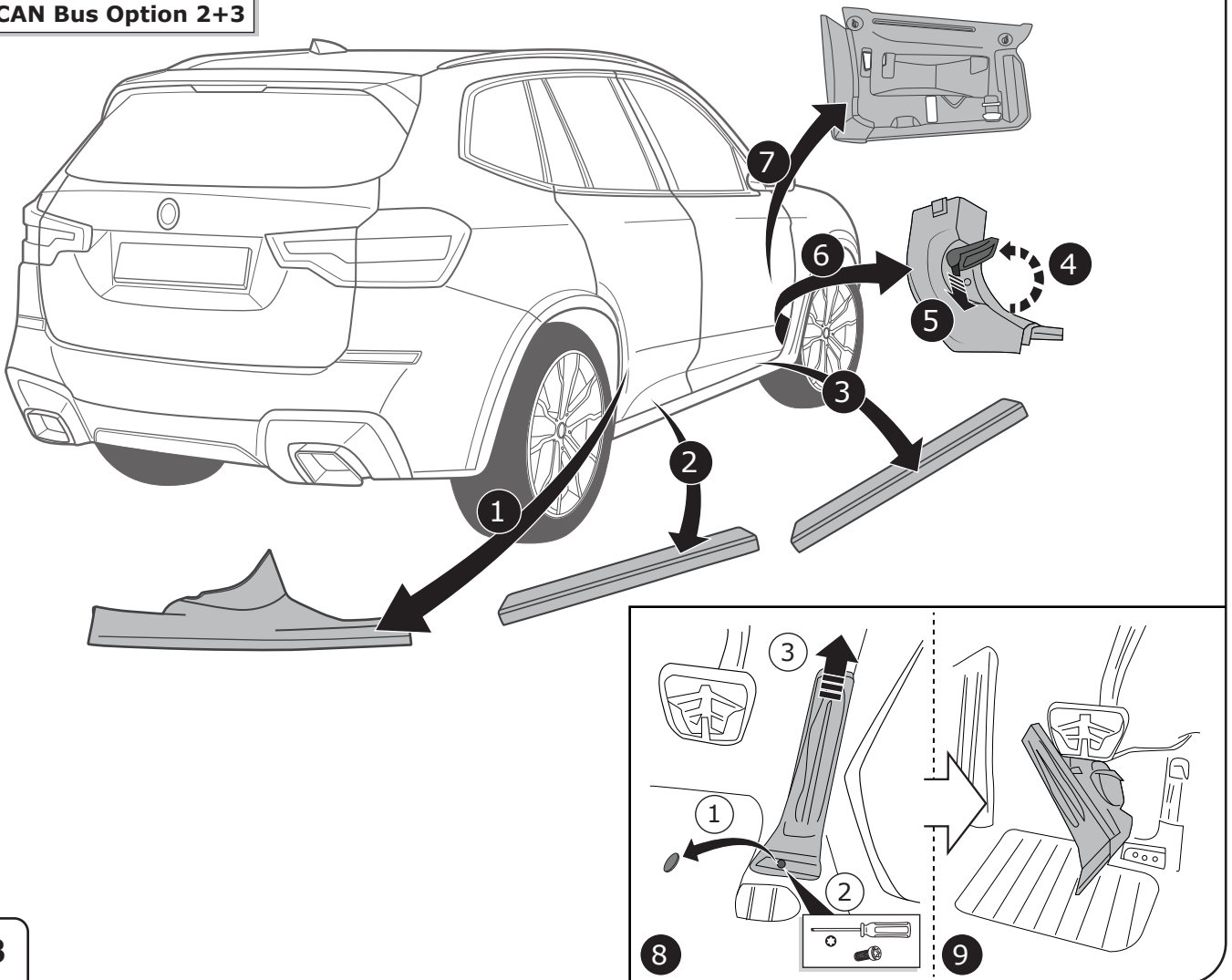

3



Option A

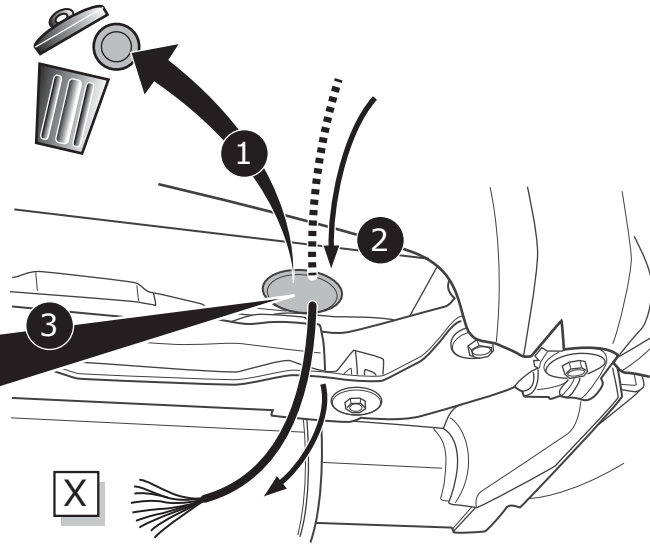

INFO

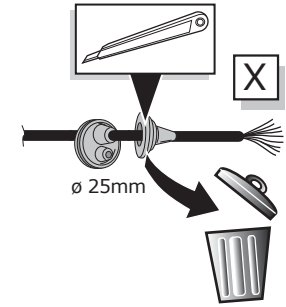

4

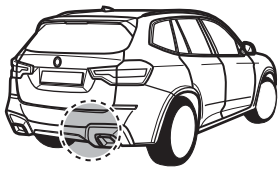

Option B

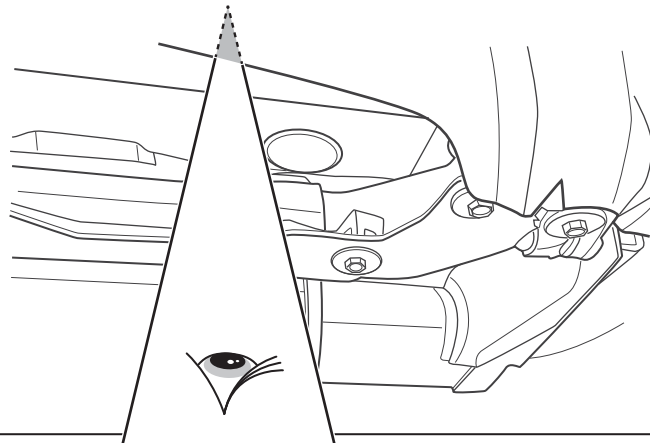

INFO

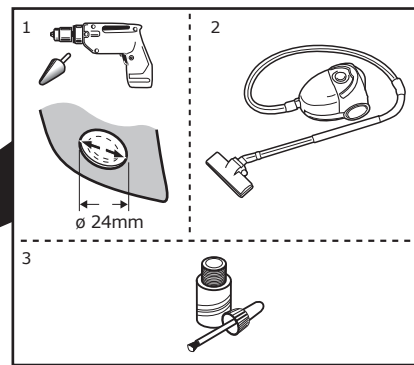
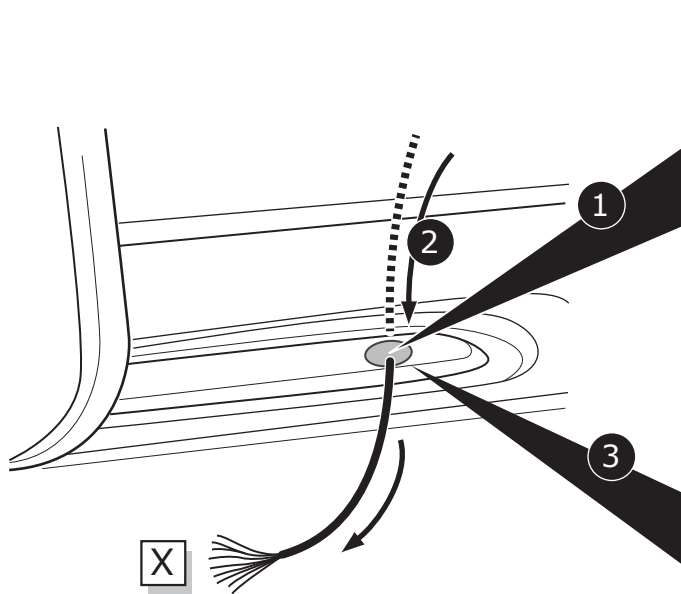
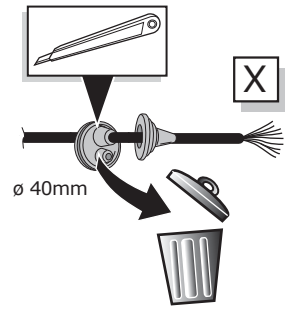

5

All models

Option 1

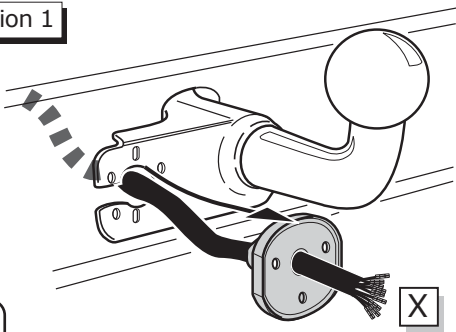

6

Option 2

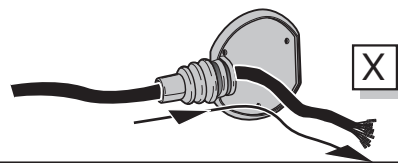

Option 3

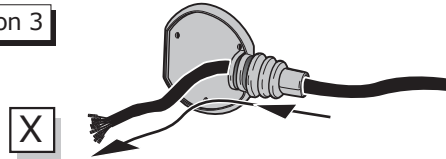

SOCKET CONNECTION

DIN/ISO 11446	←L	⊘	⊥ 1-8	R→	☀	⊘ STOP	☀	Reverse	30+	15+	⊥ 10	—	⊥ 9
	1/L	2	3/31	4/R	5/58-R	6/54	7/58-L	8	9	10	11	12	13
Pmax	21W	21W		21W	42W	3x21W	42W	21W	180W	180W			
Colour	Yellow	Blue	White	Green	Brown	Red	Black	Pink	Orange	Grey	White/Black	-	White/Red

7

Option 1

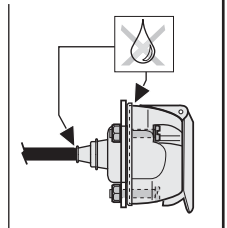
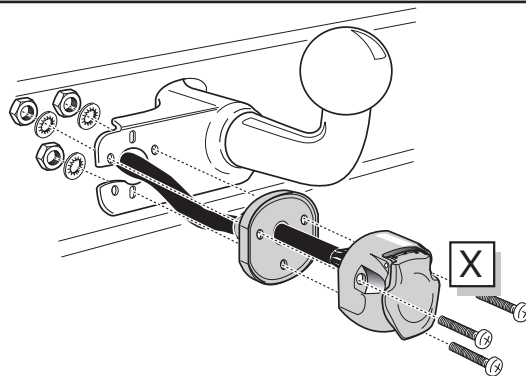

8

Option 2

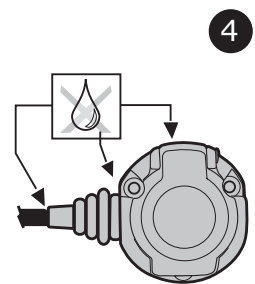
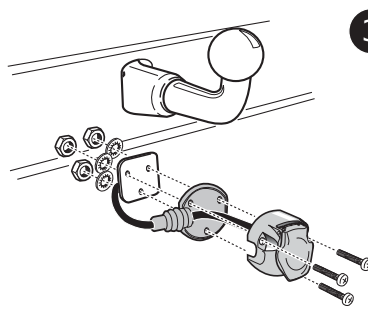
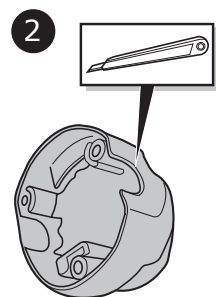
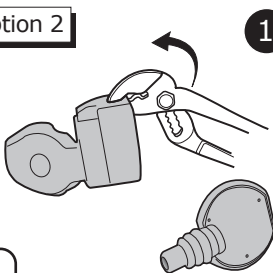

9

Option 3

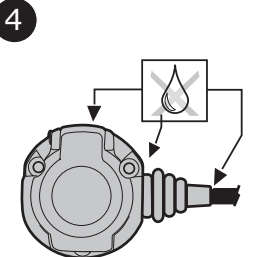
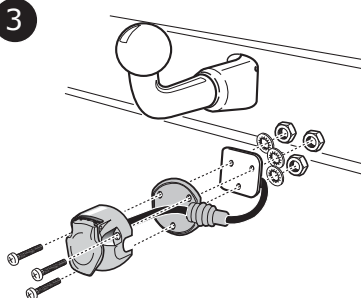
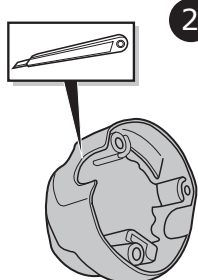
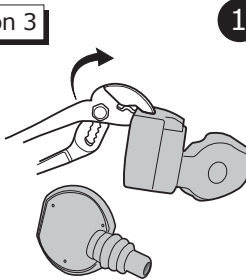

10

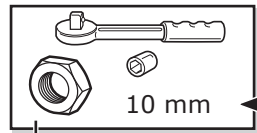

1
2

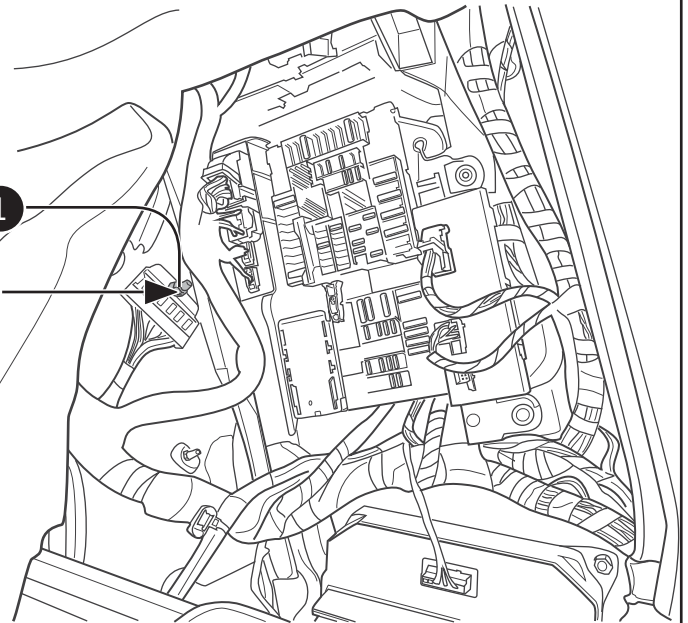

11

1

2

3

4

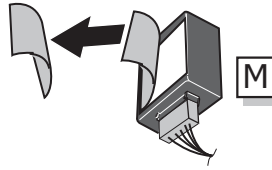
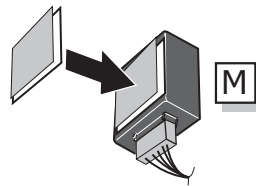
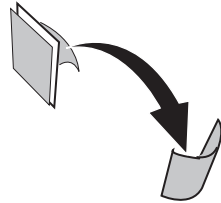
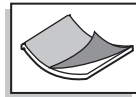
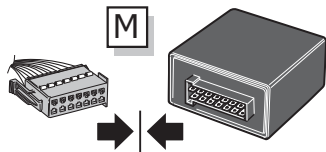
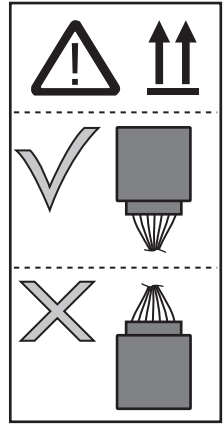

12



M

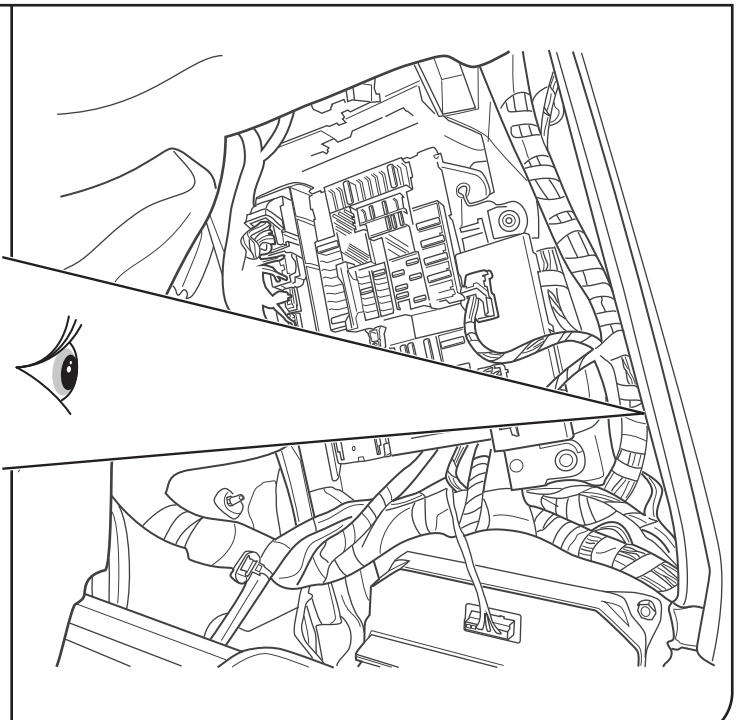
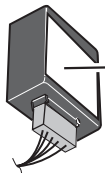

13

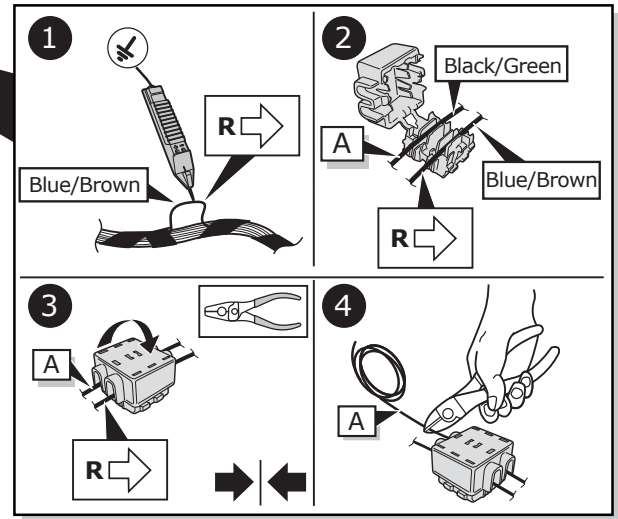
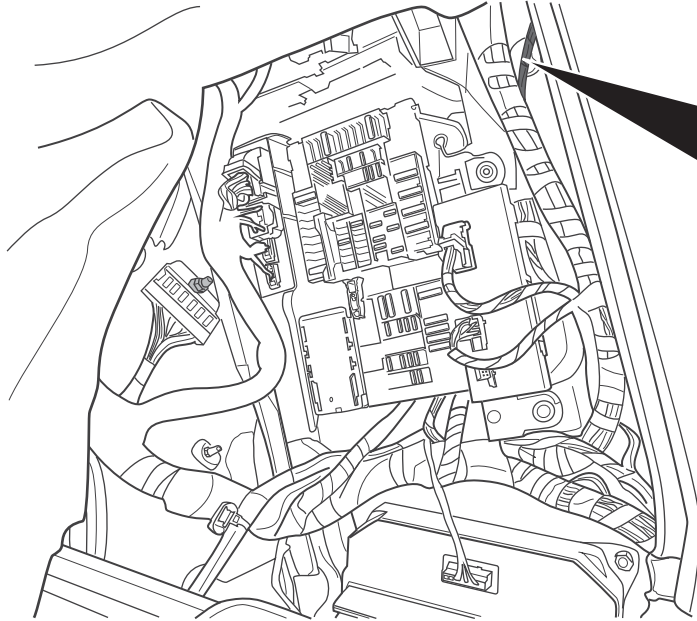
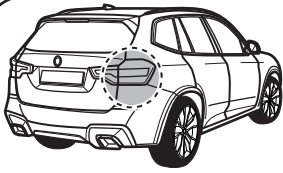

14

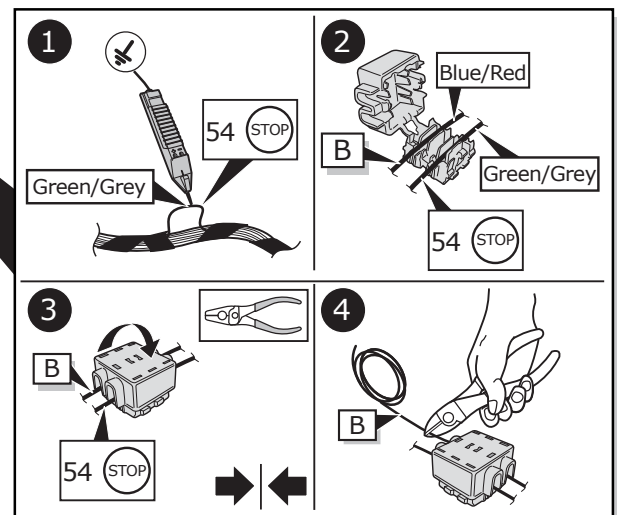
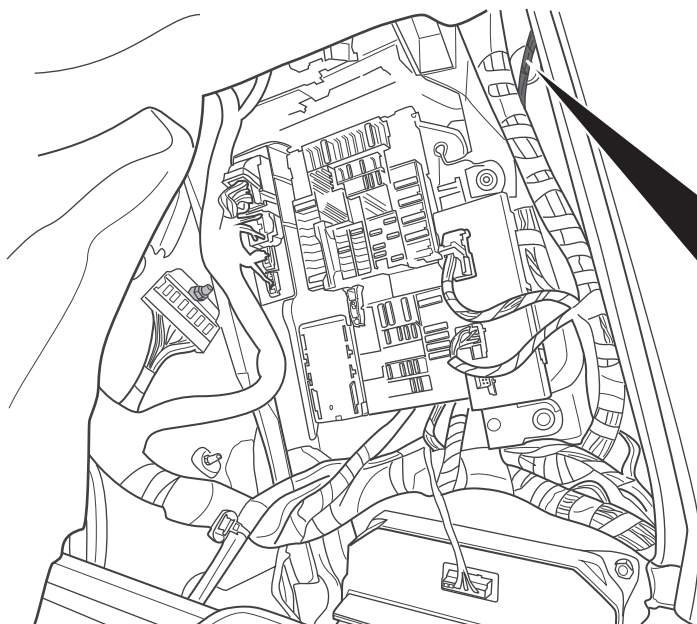

15

CAN-Data Wire

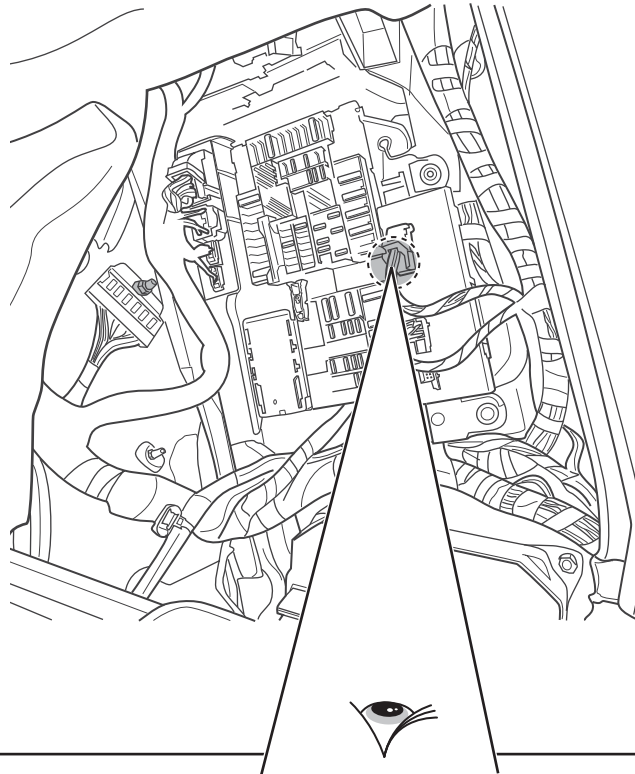
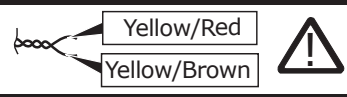

Option 1

Boot lid module

*No CAN-data wire
available in boot*



Option 2

Option 3

Option 1

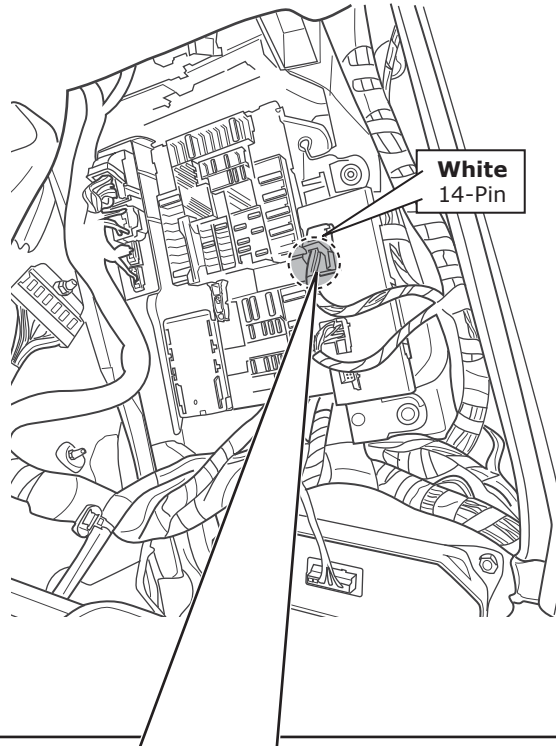

1

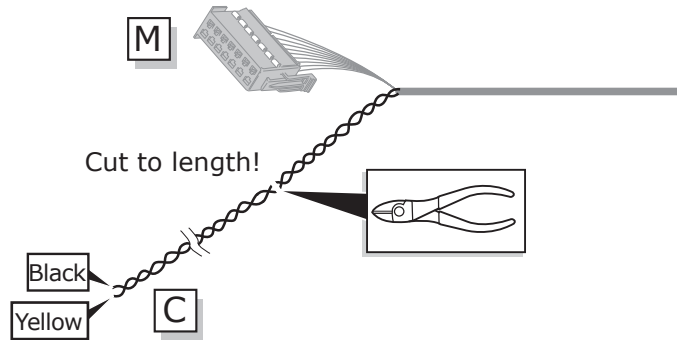

CAN-Data Wire

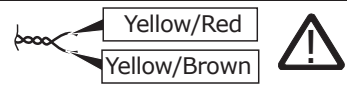

Important!
Please note
informations in
picture 1!

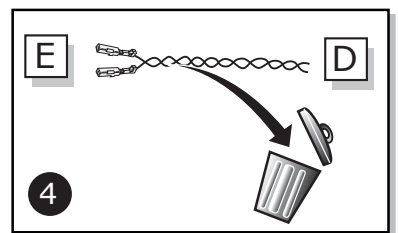

3

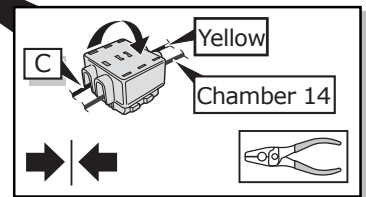

2

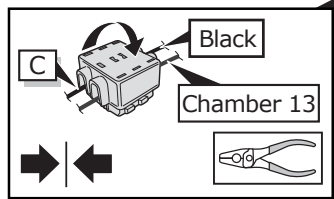

CAN High
14-pin connector **White**
Chamber 13

CAN Low
14-pin connector **White**
Chamber 14

Black

Yellow

Option 2

Option 3

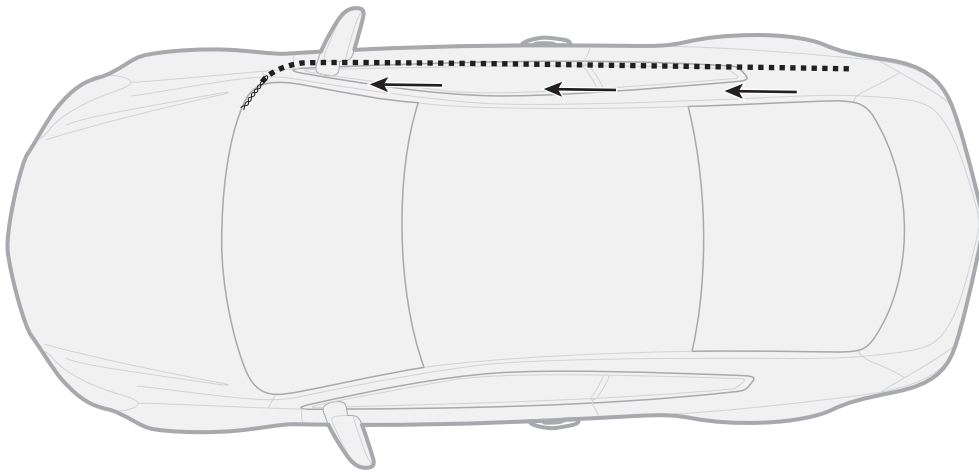

18



Option 2

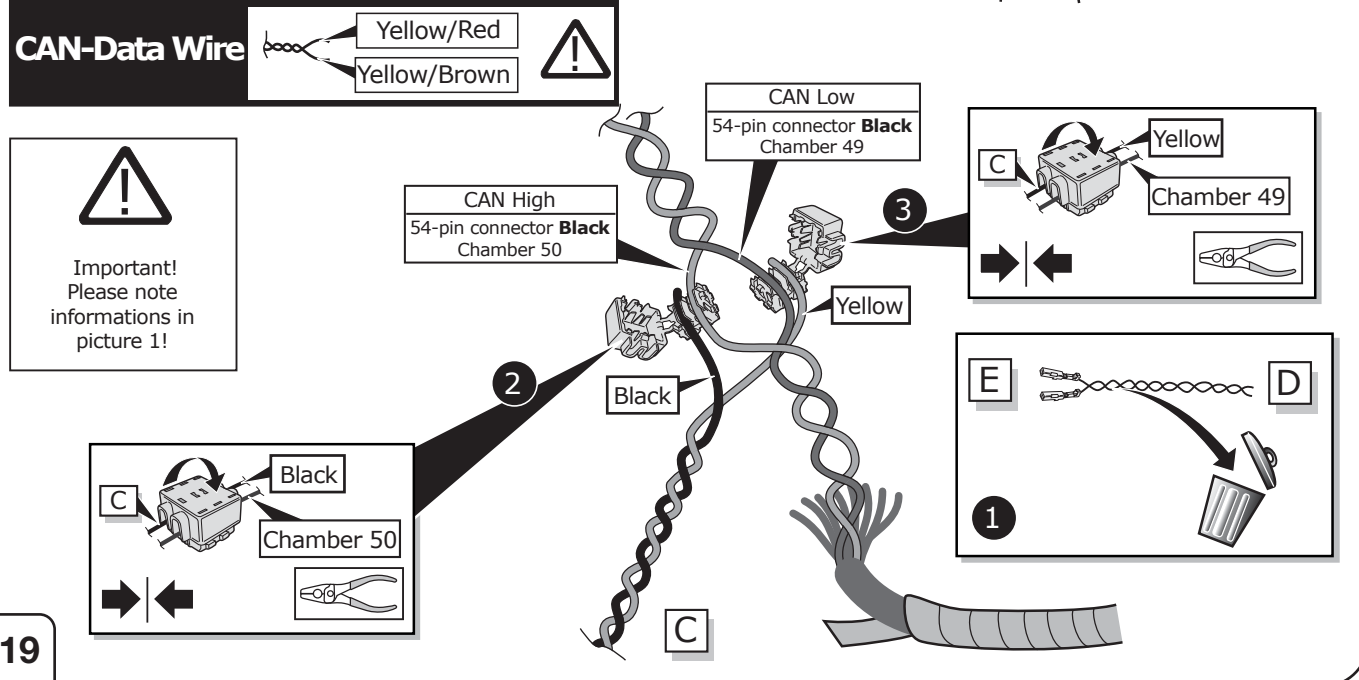
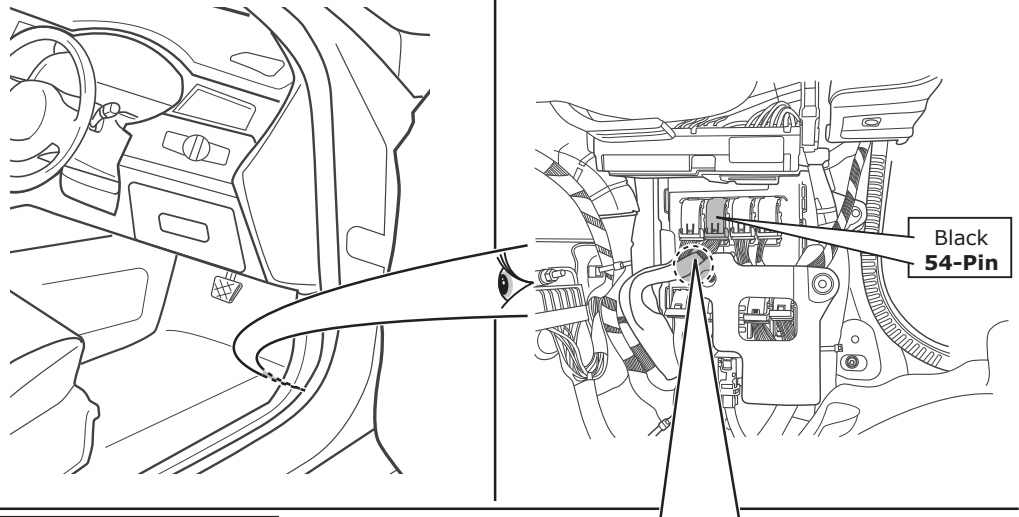

19

Option 3

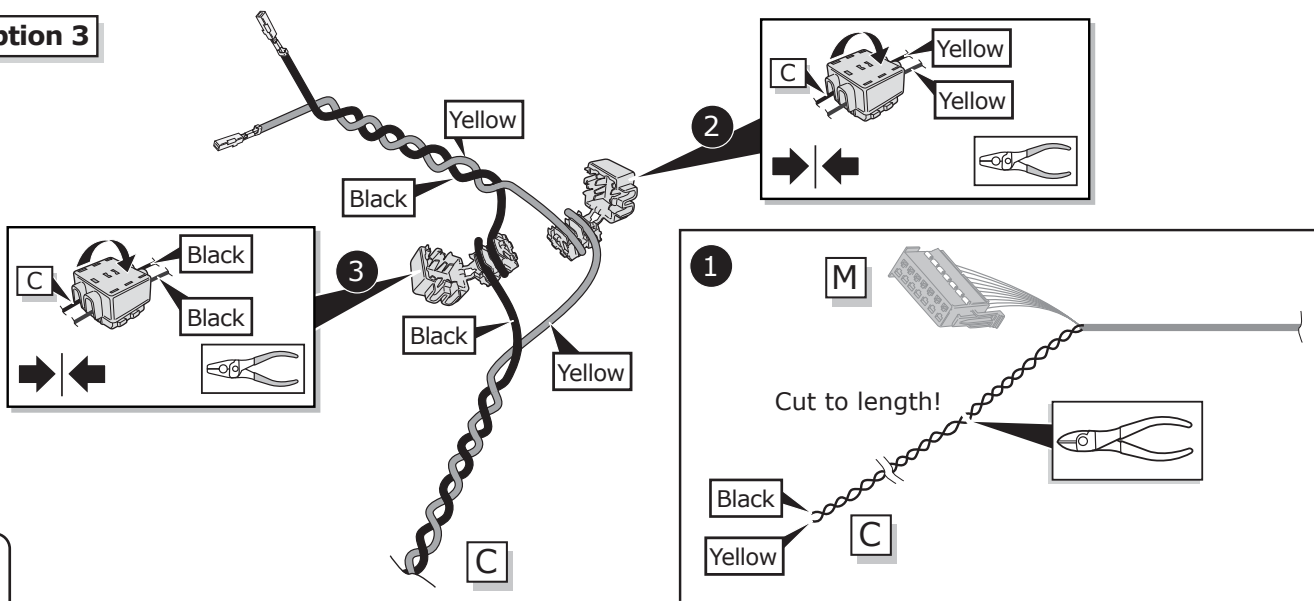

20

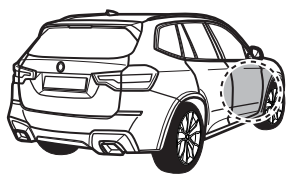

Option 3

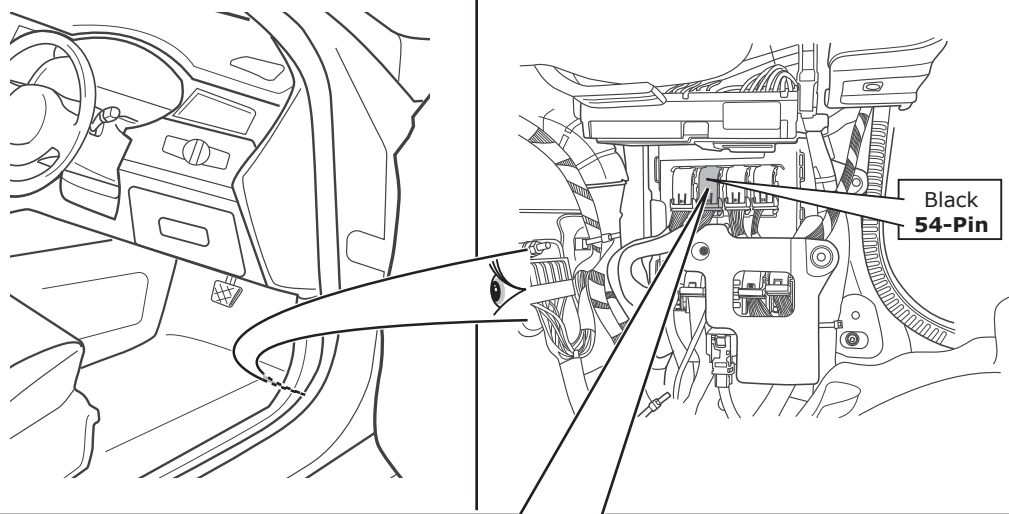

CAN-Data Wire



Important!
Please note
informations in
picture 1!

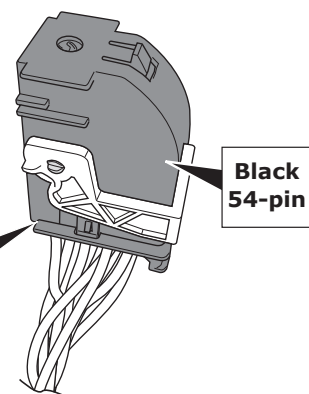
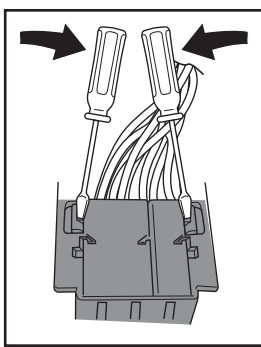

1

21

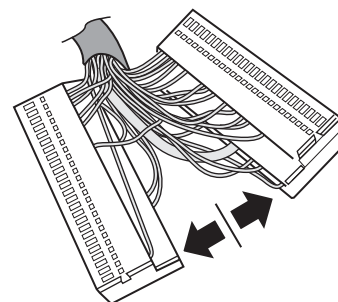
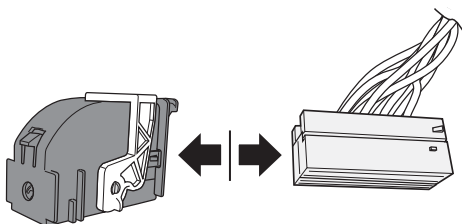

Option 3

4

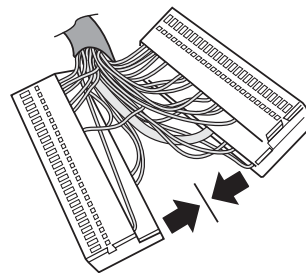
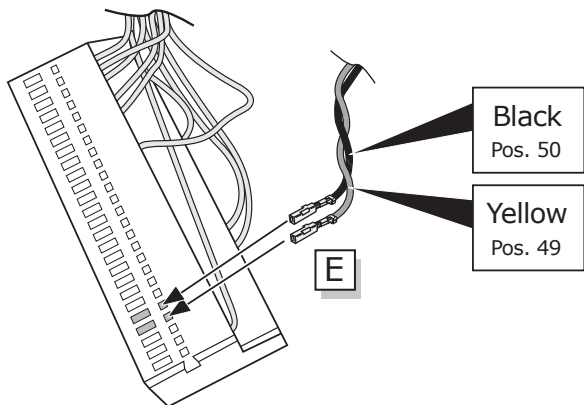

5

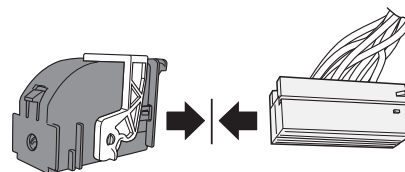

6

22

1

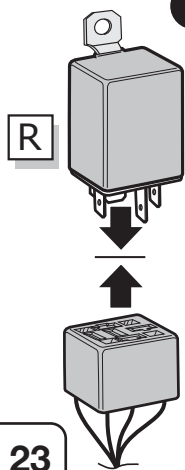

2

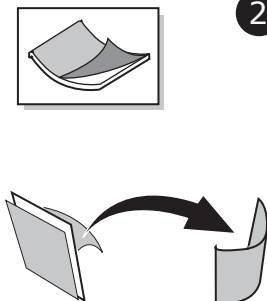

3

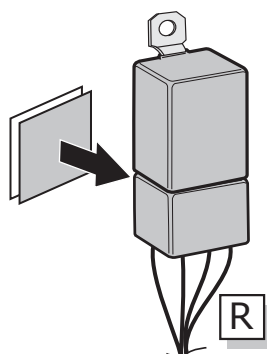

4

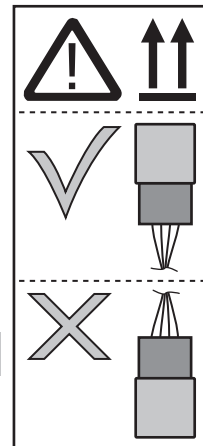
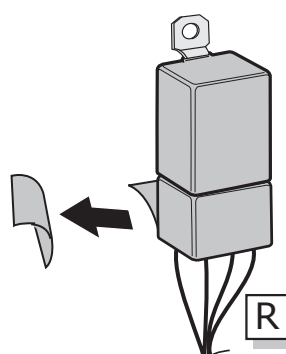

23

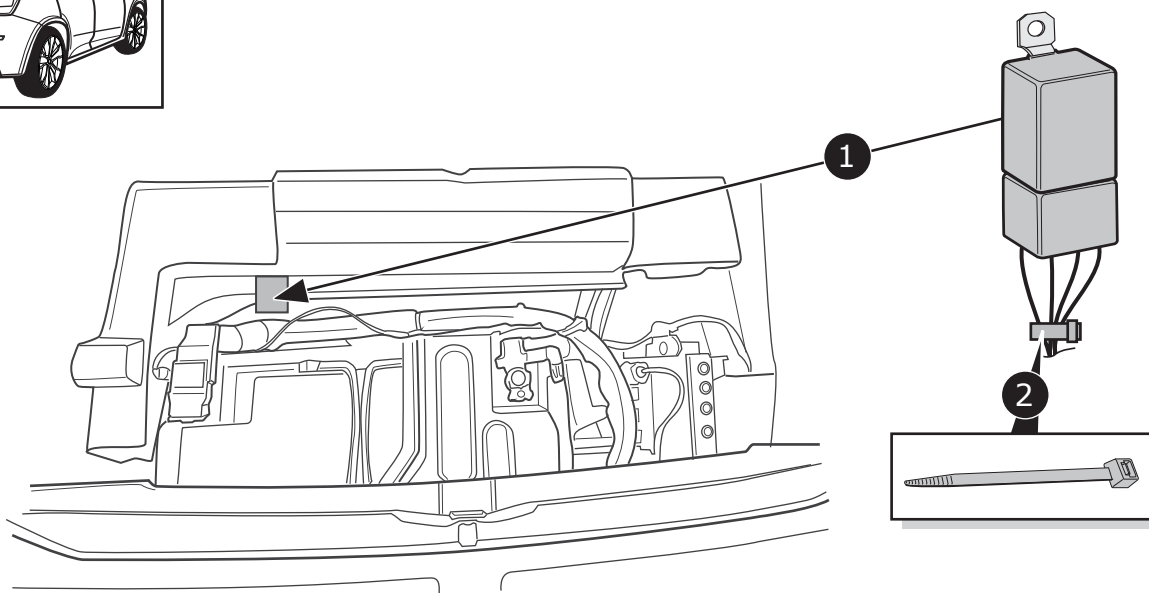
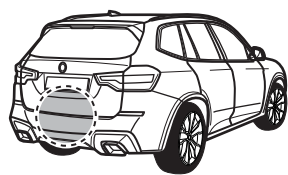

24

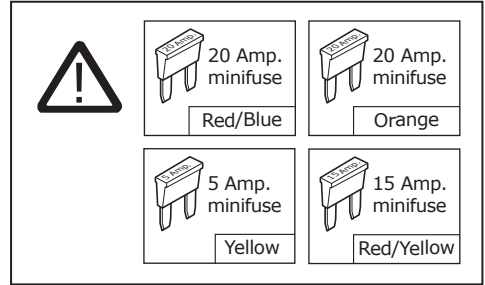
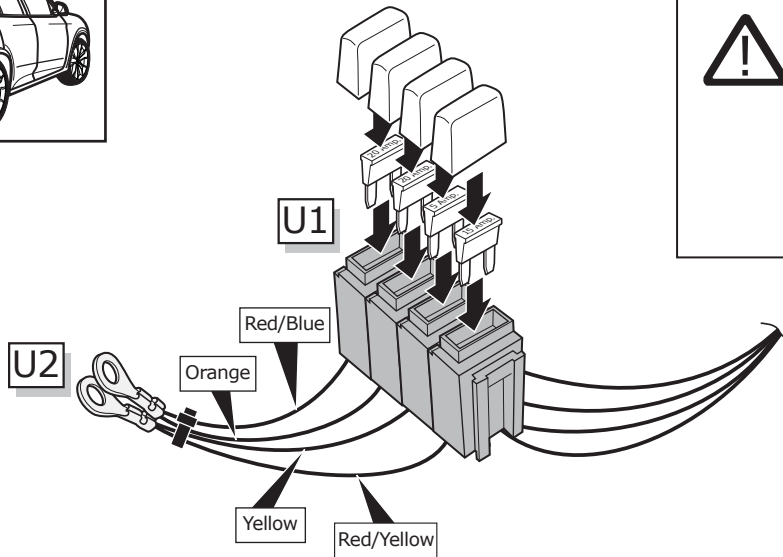

25

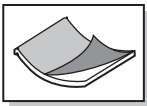

1



26

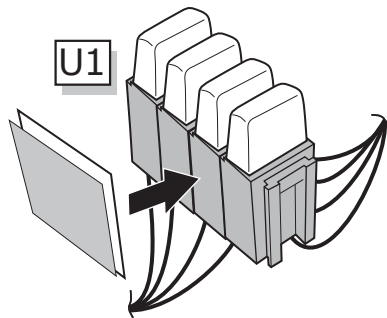

2

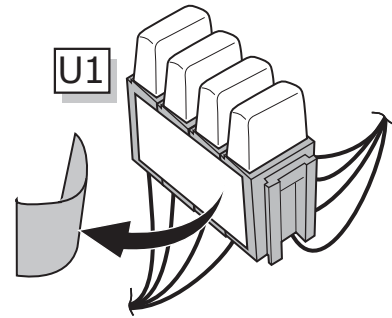

3

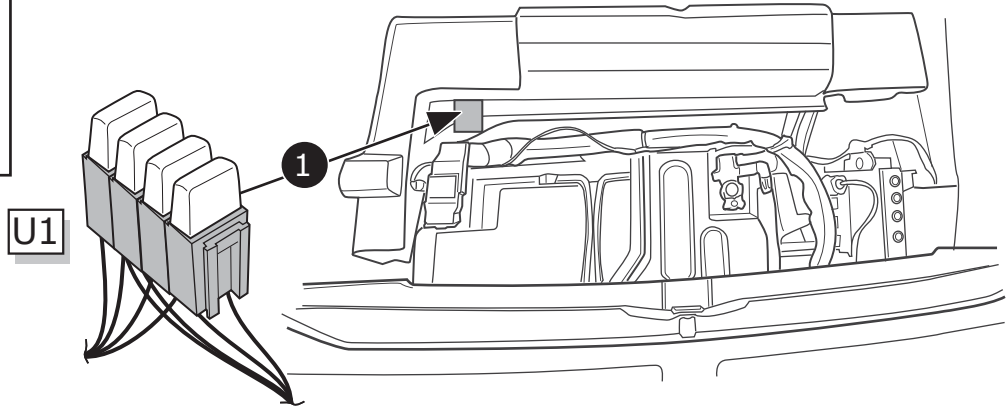

U1

1

27

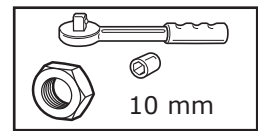
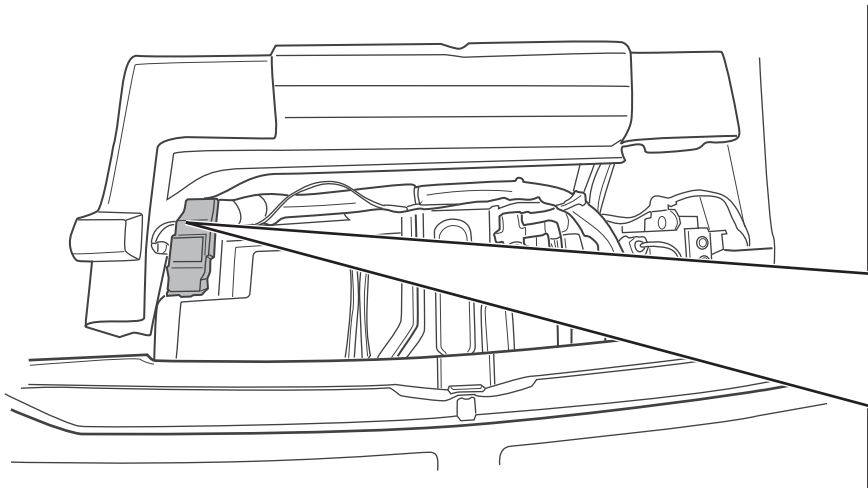

10 mm

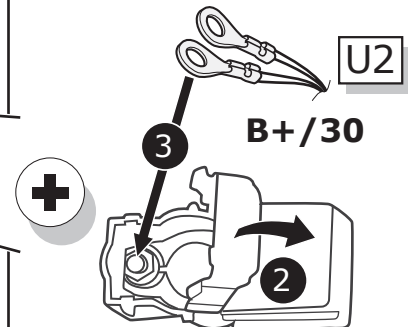

U2

B+/30

3

2

INFO

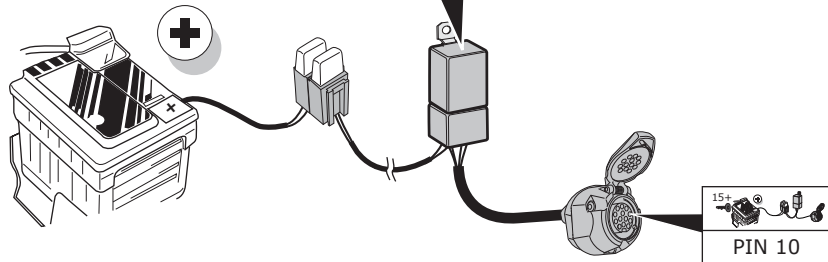
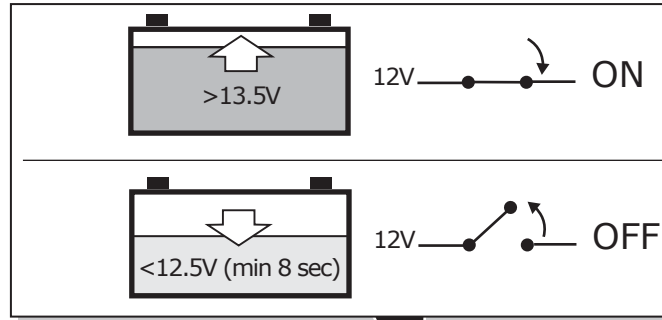

28

IMPORTANT!

The Voltage Control Module (VCM) in this kit is designed to be self switching at a pre-set voltage input. With the engine started, the switched output (e.g. caravan fridge or alternative), pin 10, will switch on at a preset figure of 13,5 volts.

When the engine is switched off, the switched output will remain live until the vehicle battery voltage drops to a preset figure of approx 12,5 volts.

NOTE: The cut-off voltage depends on the condition of the vehicle battery, power consumption of the fridge etc. In all cases, the cut-off figure is preset so the vehicle engine can be started at any time.

For vehicles equipped with smart alternators and battery monitoring devices, the general operating voltage may not be high enough to switch on the relay. Therefore, we recommend turning on the headlights when towing.

29

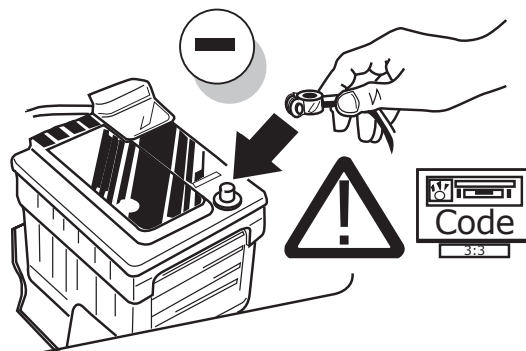

30

Optional



Trailer Simulator for 7- and 13-pin Sockets

31

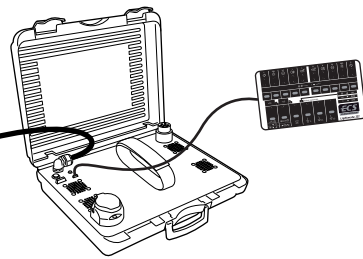
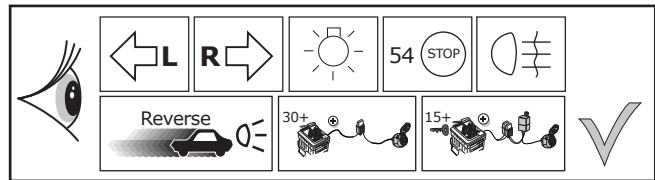
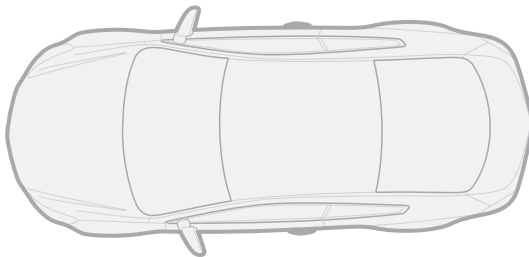

32

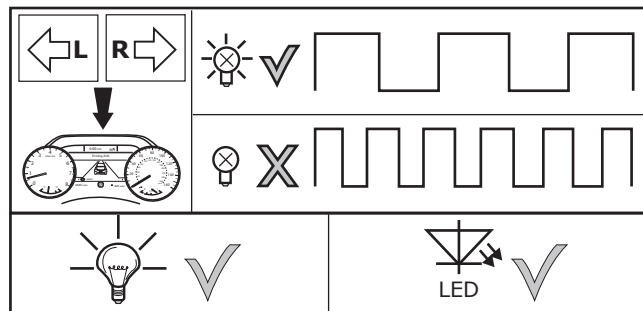
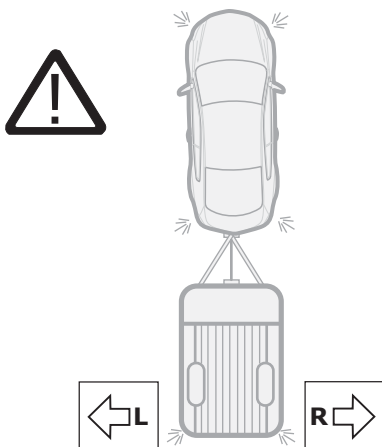

33



The following lamp functions for the trailer are not supported by all towing vehicles with DRL circuit:

- Rear lights
- Side lights
- Numberplate lights

The parking lights or dimmed headlights must be switched on to activate this function!

34

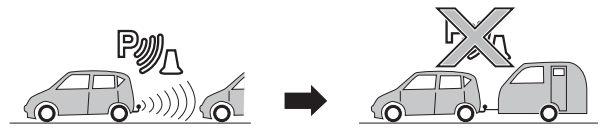

Front and rear PDC

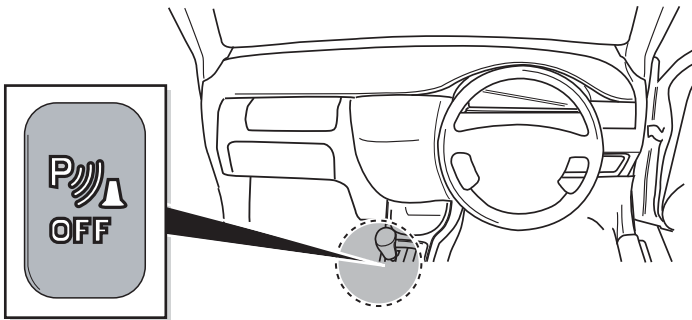

35

Optional

Adapter socket

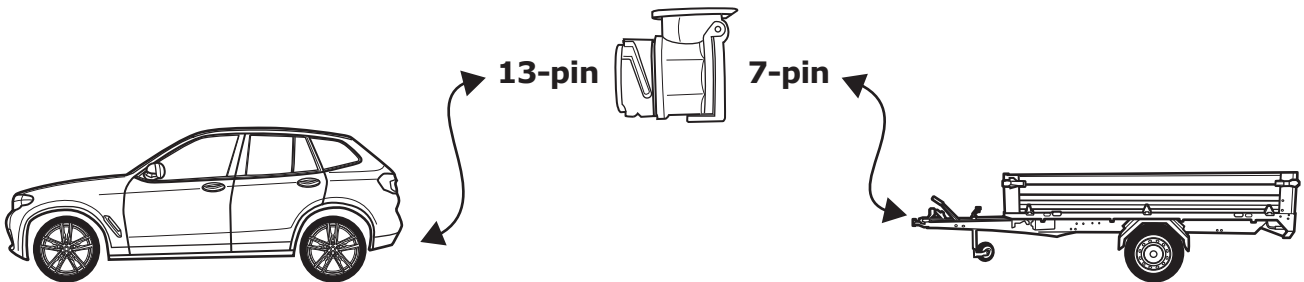

36

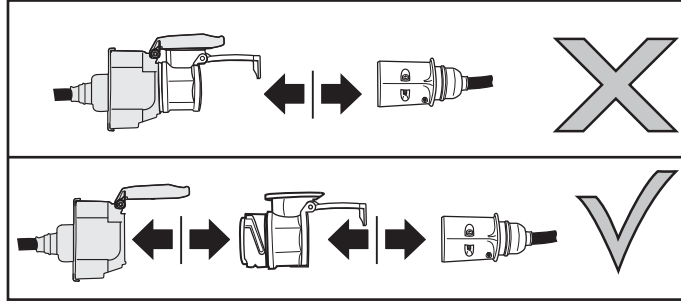
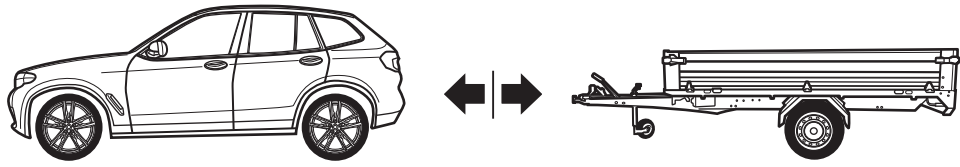

37

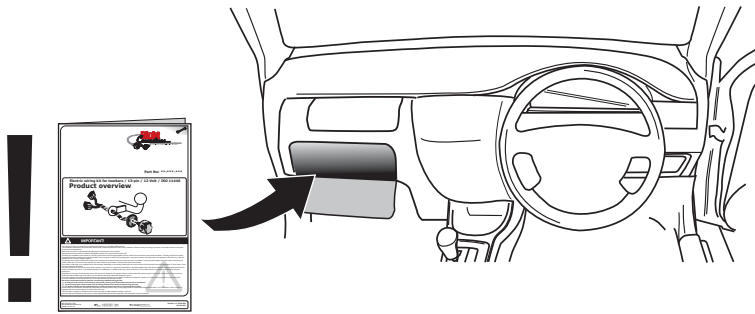

38